

## DESCRIPTION

The MP2143 is a monolithic, step-down, switch-mode converter with internal power MOSFETs. It can achieve up to 3A continuous output current from a 2.5V-to-5.5V input voltage with excellent load and line regulation. The output voltage can be regulated as low as 0.6V.

Constant-on-time control provides fast transient response and eases loop stabilization. Fault-condition protections include cycle-by-cycle current limiting and thermal shutdown.

The MP2143 is available in small TSOT23-8 package and requires only a minimal number of readily-available standard external components.

The MP2143 is ideal for a wide range of applications including high-performance DSPs, FPGAs, smartphones, portable instruments, and DVD drivers.

## FEATURES

- Wide 2.5V-to-5.5V Operating Input Range
- Output Voltage as Low as 0.6V
- 100% Duty Cycle in Dropout
- Up to 3A Output Current
- Low I<sub>Q</sub>: 40µA
- 80mΩ and 40mΩ Internal Power MOSFET Switches
- Default 1.2MHz Switching Frequency
- EN and Power-Good for Power Sequencing
- Cycle-by-Cycle Over-Current Protection
- Auto Discharge at Power Off
- Short-Circuit Protect with Hiccup Mode
- Stable with Low-ESR Output Ceramic Capacitors
- Available in a TSOT23-8 Package

## APPLICATIONS

- Low Voltage I/O System Power
- Handheld/Battery-powered Systems
- Wireless/Networking Cards

All MPS parts are lead-free, halogen free, and adhere to the RoHS directive. For MPS green status, please visit MPS website under Quality Assurance. "MPS" and "The Future of Analog IC Technology" are Registered Trademarks of Monolithic Power Systems, Inc.

## TYPICAL APPLICATION

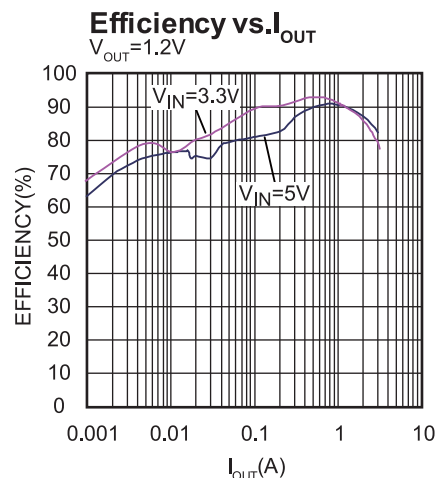
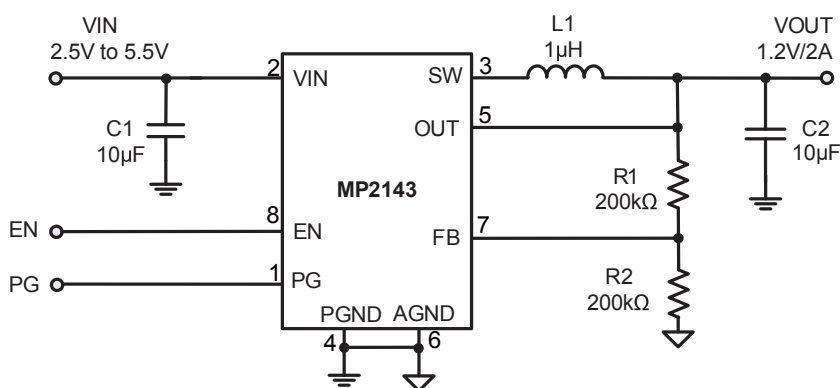

**ORDERING INFORMATION**

Part Number*	Package	Top Marking
MP2143DJ	TSOT23-8	See Below

\* For Tape & Reel, add suffix –Z (e.g. MP2143DJ–Z);  
 For RoHS compliant packaging, add suffix –LF (e.g. MP2143DJ–LF–Z)

**TOP MARKING**

|ACEY

ACE: product code of MP2143DJ;  
 Y: year code;

**PACKAGE REFERENCE**

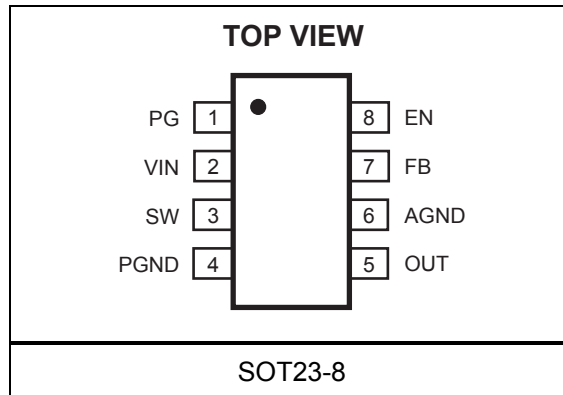

**ABSOLUTE MAXIMUM RATINGS** <sup>(1)</sup>

Supply Voltage V<sub>IN</sub> ..... 6V  
 V<sub>SW</sub> .....  
 -0.3V (-5V for < 10ns) to V<sub>IN</sub>+0.3V (10V for <10ns)  
 All Other Pins .....-0.3V to +6 V  
 Junction Temperature ..... 150°C  
 Lead Temperature ..... 260°C  
 Continuous Power Dissipation (T<sub>A</sub> = 25°C) <sup>(2)</sup>  
 ..... 1.25W  
 Storage Temperature ..... -65°C to +150°C

**Recommended Operating Conditions** <sup>(3)</sup>

Supply Voltage V<sub>IN</sub> ..... 2.5V to 5.5V  
 Output Voltage V<sub>OUT</sub> ..... 0.6V to V<sub>IN</sub> -0.5V  
 Operating Junction Temp. (T<sub>J</sub>) ..... -40°C to +125°C

**Thermal Resistance** <sup>(4)</sup>      θ<sub>JA</sub>      θ<sub>JC</sub>  
 TSOT23-8 ..... 100 ..... 55... °C/W

**Notes:**

- 1) Exceeding these ratings may damage the device.
- 2) The maximum allowable power dissipation is a function of the maximum junction temperature T<sub>J</sub> (MAX), the junction-to-ambient thermal resistance θ<sub>JA</sub>, and the ambient temperature T<sub>A</sub>. The maximum allowable continuous power dissipation at any ambient temperature is calculated by P<sub>D</sub> (MAX) = (T<sub>J</sub> (MAX)-T<sub>A</sub>)/θ<sub>JA</sub>. Exceeding the maximum allowable power dissipation will cause excessive die temperature, and the regulator will go into thermal shutdown. Internal thermal shutdown circuitry protects the device from permanent damage.
- 3) The device is not guaranteed to function outside of its operating conditions.
- 4) Measured on JESD51-7, 4-layer PCB.

**ELECTRICAL CHARACTERISTICS** <sup>(5)</sup>
**V<sub>IN</sub> = 5V, T<sub>A</sub> = 25°C, unless otherwise noted.**

Parameter	Symbol	Condition	Min	Typ	Max	Units
Feedback Voltage	V <sub>FB</sub>	2.5V ≤ V <sub>IN</sub> ≤ 5.5V	-1.5%	0.600	+1.5%	V/%
		T <sub>A</sub> =-40°C to +85°C	-2%		+2%	
Feedback Current	I <sub>FB</sub>	V <sub>FB</sub> = 0.63V		10		nA
PFET Switch ON Resistance	R <sub>DSON_P</sub>			80		mΩ
NFET Switch ON Resistance	R <sub>DSON_N</sub>			40		mΩ
Switch Leakage		V <sub>EN</sub> = 0V, V <sub>IN</sub> = 5V V <sub>SW</sub> = 0V and 5V		0.1	2	μA
PFET Current Limit			4.2	4.8		A
NFET Switch Sinking Current	I <sub>NSW</sub>	V <sub>OUT</sub> =1.2V, V <sub>FB</sub> =0.7V		100		μA
ON Time	t <sub>ON</sub>	V <sub>IN</sub> =5V, V <sub>OUT</sub> =1.2V		200		nS
		V <sub>IN</sub> =3.6V, V <sub>OUT</sub> =1.2V		277		
Switching frequency	f <sub>s</sub>	V <sub>IN</sub> =5V, V <sub>OUT</sub> =1.2V, I <sub>OUT</sub> =1A	-20%	1200	+20%	kHz
		T <sub>A</sub> =-40°C to +85°C	-25%	1200	+25%	kHz
Minimum OFF Time	t <sub>MIN-OFF</sub>			50		ns
Soft-Start Time	t <sub>SS-ON</sub>			1.3		ms
Soft-Stop Time	t <sub>SS-OFF</sub>			1		ms
Power-Good Upper Trip Threshold	PG <sub>H</sub>	FB voltage respect to the regulation		+10%		%
Power-Good Lower Trip Threshold	PG <sub>L</sub>			-10%		%
Power-Good Delay	PG <sub>D</sub>			110		μs
Power-Good Sink Current Capability	V <sub>PG-L</sub>	Sink 1mA			0.4	V
Power-Good Logic High Voltage	V <sub>PG-H</sub>	V <sub>IN</sub> =5V, V <sub>FB</sub> =0.6V	4.9			V
Power-Good Internal Pull-Up Resistor	R <sub>PG</sub>			500		kΩ
Under-Voltage Lockout Threshold Rising			2.0	2.2	2.4	V
Under-Voltage Lockout Threshold Hysteresis				150		mV
EN Input Logic Low Voltage					0.4	V
EN Input Logic High Voltage			1.2			V
EN Input Current		V <sub>EN</sub> =2V		2		μA
		V <sub>EN</sub> =0V		0.1		μA

**ELECTRICAL CHARACTERISTICS** <sup>(5)</sup> *(continued)*

V<sub>IN</sub> = 5V, T<sub>A</sub> = 25°C, unless otherwise noted.

Parameter	Symbol	Condition	Min	Typ	Max	Units
Supply Current (Shutdown)		V <sub>EN</sub> =0V		0.1		µA
Supply Current (Quiescent)		V <sub>EN</sub> =2V, V <sub>IN</sub> =3.6V		40		µA
Thermal Shutdown				150		°C
Thermal Hysteresis				30		°C

**Notes:**

5) Guaranteed by design.

## TYPICAL PERFORMANCE CHARACTERISTICS

V<sub>IN</sub> = 5V, V<sub>OUT</sub> = 1.2V, L = 1.0 $\mu$ H, C<sub>OUT</sub>=22 $\mu$ F, T<sub>A</sub> = 25°C, unless otherwise noted.

**Efficiency Vs. I<sub>out</sub>**

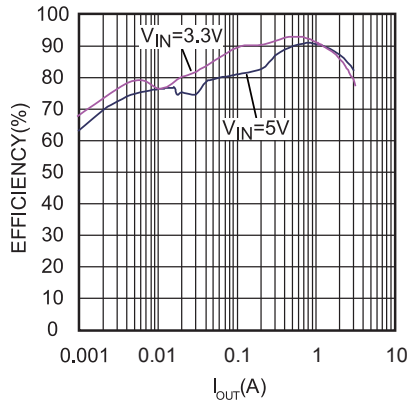

**Efficiency Vs. I<sub>out</sub>**

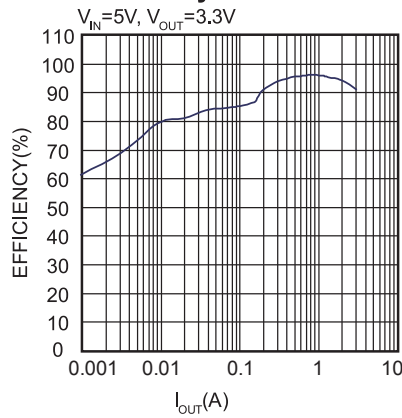

**Quiescent Current vs. Input Voltage**

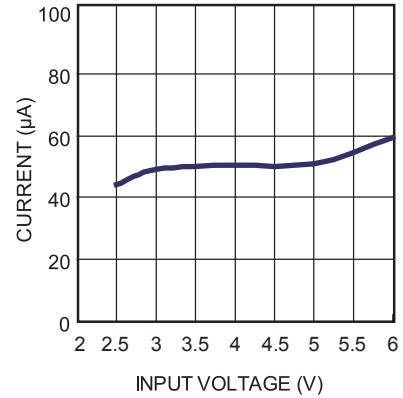

**Shutdown Current vs. Input Voltage**

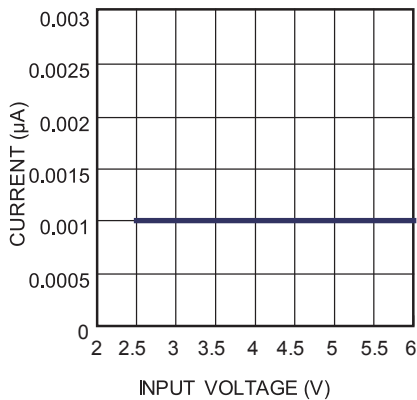

**Load Regulation**

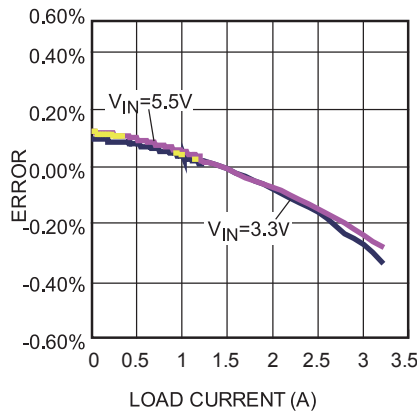

**Line Regulation**

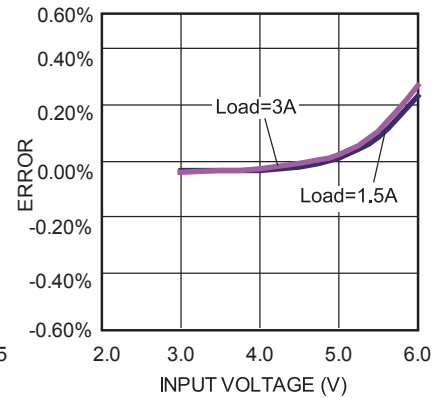

**Case Temp Rise**

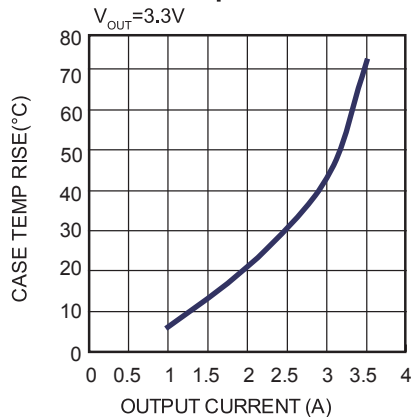

**TYPICAL PERFORMANCE CHARACTERISTICS (continued)**

V<sub>IN</sub> = 5V, V<sub>OUT</sub> = 1.2V, L = 1.0µH, C<sub>OUT</sub>=22µF, T<sub>A</sub> = 25°C, unless otherwise noted

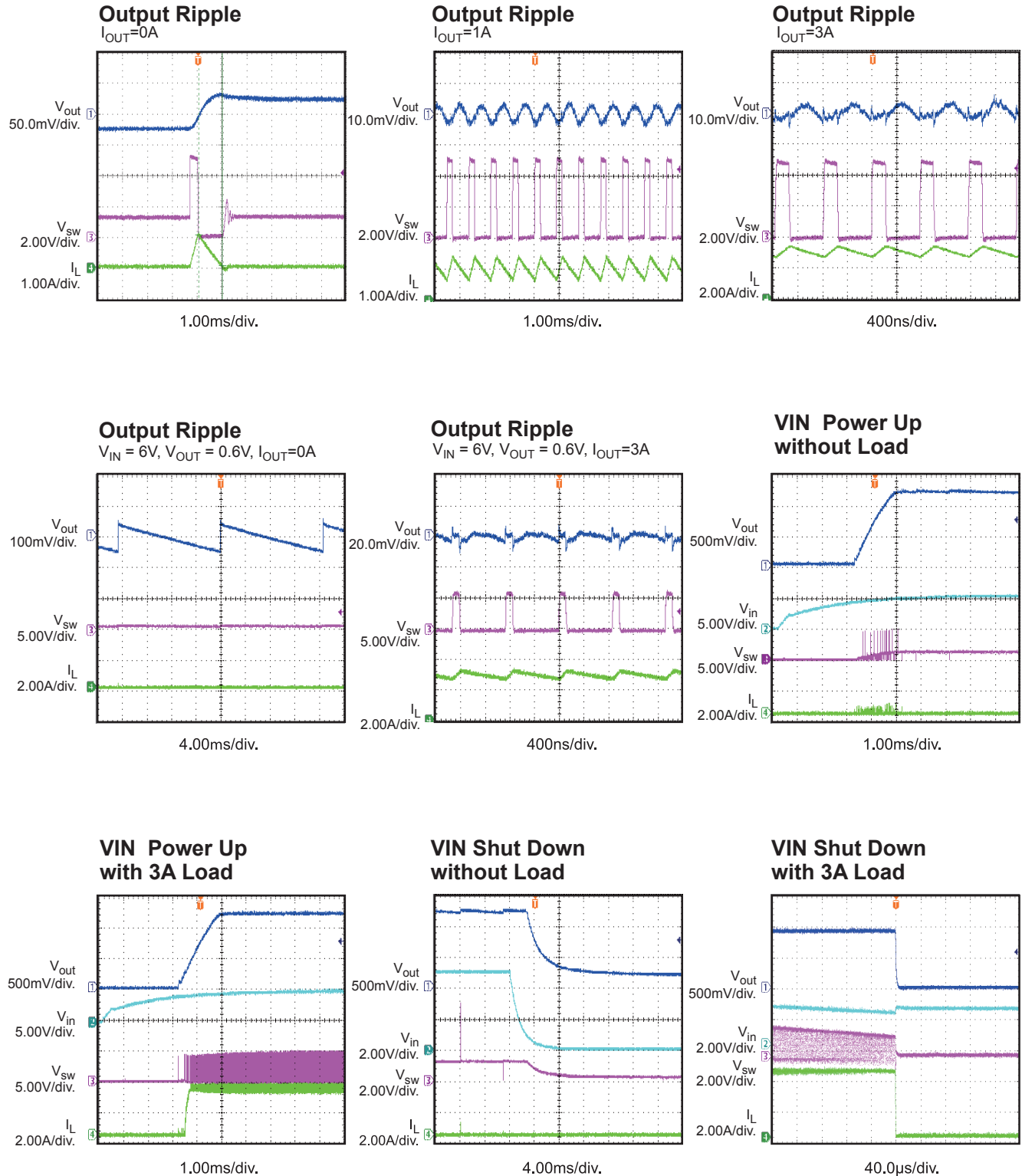

**.TYPICAL PERFORMANCE CHARACTERISTICS (continued)**

$V_{IN} = 5V$ ,  $V_{OUT} = 1.2V$ ,  $L = 1.0\mu H$ ,  $C_{OUT}=22\mu F$ ,  $T_A = 25^\circ C$ , unless otherwise noted.

**EN Start Up without Load**

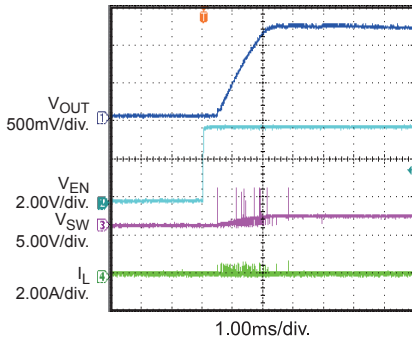

**EN Start Up with 3A Load**

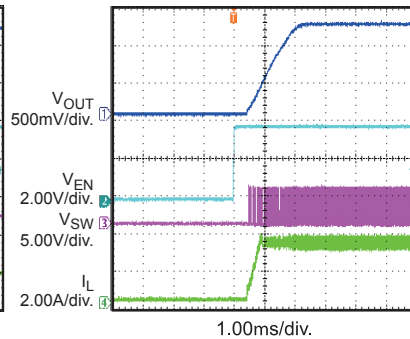

**EN Shut Down without Load**

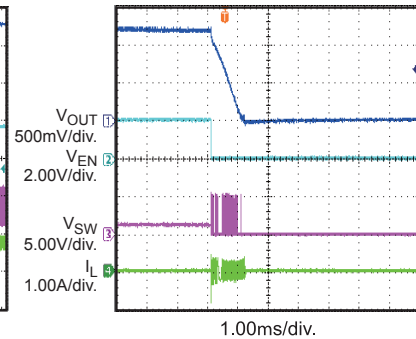

**EN Shut Down with 3A Load**

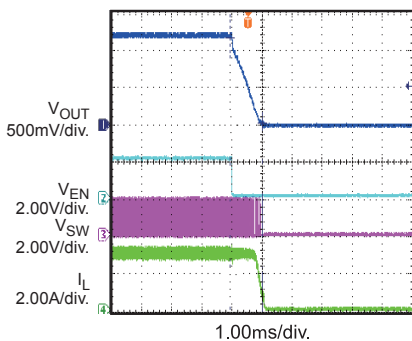

**Power Good On without Load**

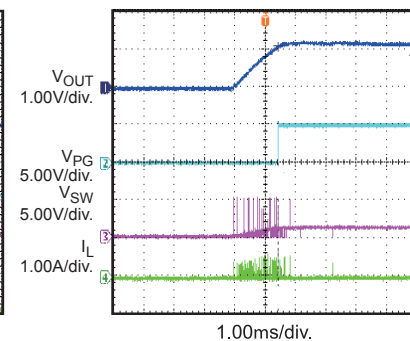

**Power Good On with 3A Load**

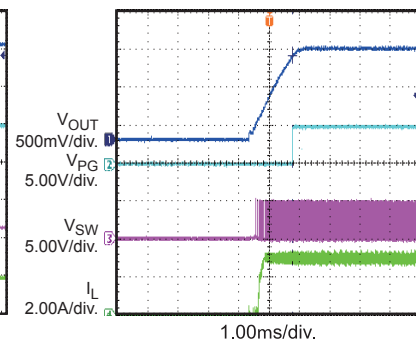

**Power Good Off without Load**

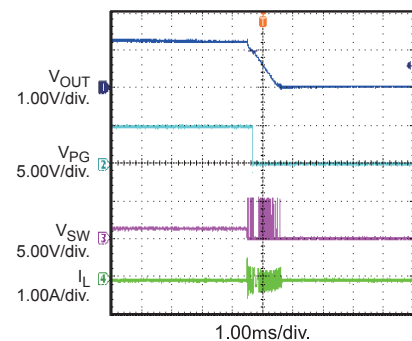

**Power Good Off with 3A Load**

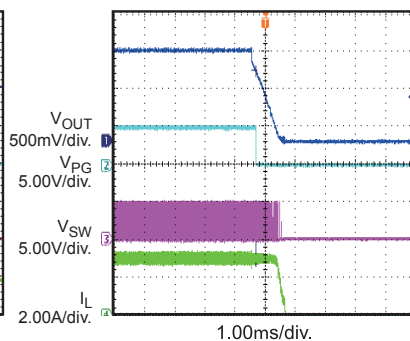

**Load Transient Response**

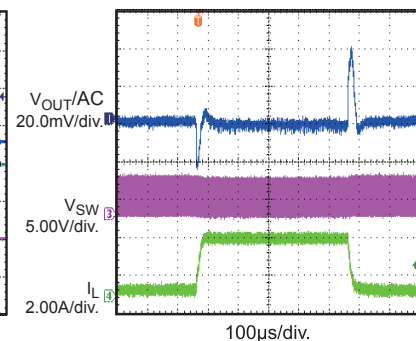

### TYPICAL PERFORMANCE CHARACTERISTICS (continued)

$V_{IN} = 5V$ ,  $V_{OUT} = 1.2V$ ,  $L = 1.0\mu H$ ,  $C_{OUT} = 22\mu F$ ,  $T_A = 25^\circ C$ , unless otherwise noted.

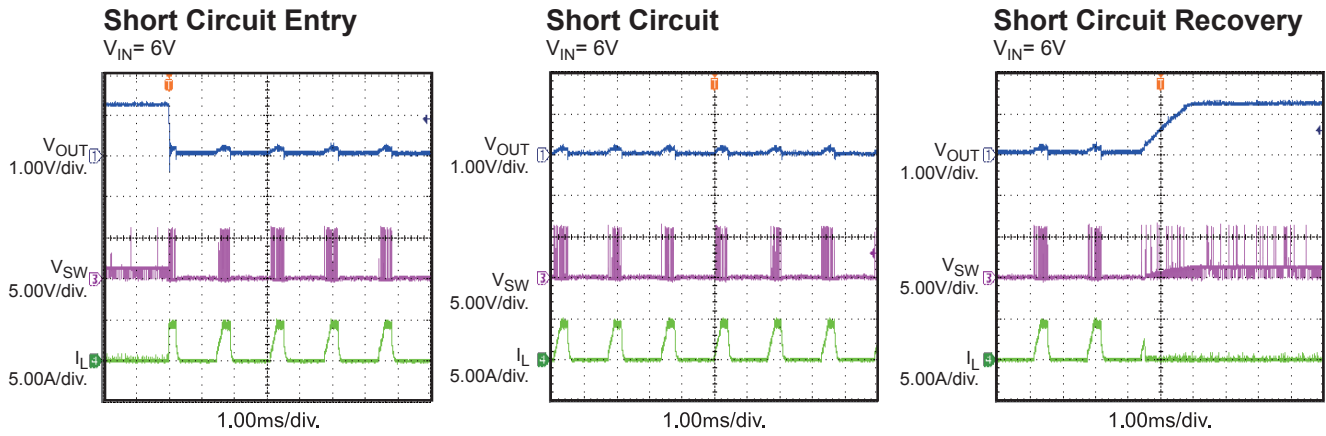



## PIN FUNCTIONS

TSOT23 Pin #	Name	Description
1	PG	Power-Good Indicator. The pin output is an open drain that connects to VIN by an internal pull-up resistor. PG is pulled up to VIN when the FB voltage is within $\pm 10\%$ of the regulation level. If FB voltage is out of that regulation range, it is LOW.
2	VIN	Supply Voltage. The MP2143 operates from a 2.5V-to-5.5V unregulated input. C1 prevents large voltage spikes from appearing at the input.
3	SW	Switch Output
4	PGND	Power Ground
5	OUT	Input Sense. For output voltage feedback
6	AGND	Analog ground. Reference for the internal control circuit.
7	FB	Feedback pin. Connect an external resistor divider from the output to AGND to set the output voltage.
8	EN	On/Off Control

## FUNCTIONAL BLOCK DIAGRAM

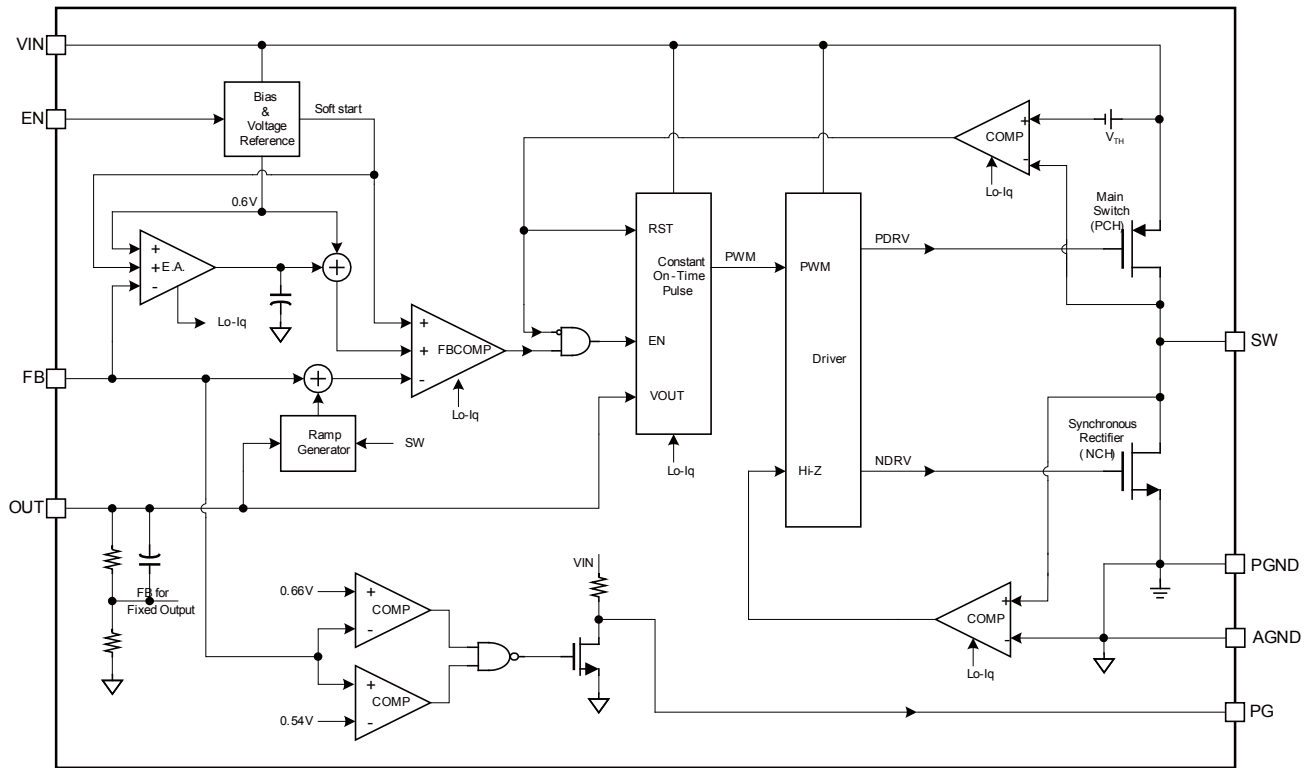

Figure 1: Functional Block Diagram

## OPERATION

The MP2143 uses constant on-time control with input-voltage feed-forward to stabilize the switching frequency over its full input range. At light load, the MP2143 employs a proprietary control over the low-side MOSFET (LS-FET) and inductor current to eliminate ringing on switching node and to improve efficiency.

### Constant On-Time Control

When compared to fixed-frequency PWM control, constant on-time control offers a simpler control loop and faster transient response. By using input-voltage feed-forward, the MP2143 maintains a nearly constant switching frequency across the entire input and output voltage range. The switching pulse ON time can be estimated as:

$$t_{ON} = \frac{V_{OUT}}{V_{IN}} \cdot 0.833\mu s$$

To prevent inductor current runaway during the load transient, the MP2143 has a fixed minimum OFF time of 50ns. However, this minimum OFF time limit does not affect the operation of the MP2143 in steady state in any way.

### Light Load Operation

In light load condition, the MP2143 uses a proprietary control scheme to save power and improve efficiency: It gradually ramps down the LS-FET current to its minimum instead of turning off the LS-FET immediately when the inductor current starts to reverse. The gradual current drop avoids ringing at the switching node that always occurs in discontinuous conduction mode (DCM) operation.

Considering the internal circuit propagation time, the typical delay is 50ns. It means the inductor current still fall after the ZCD is trigger in this delay. If the inductor current falling slew rate is fast (V<sub>OUT</sub> voltage is high or close to V<sub>IN</sub>), the low side MOSFET is turned off and inductor current may be negative. This phenomena will cause MP2143 can not enter DCM operation. If the DCM mode is required, the off time of low side MOSFET in CCM should be longer than 100ns. For example, V<sub>in</sub> is 3.6V and V<sub>o</sub> is 3.3V, the off time in CCM is 50ns. It is difficult to enter

DCM at light load. And using smaller inductor can improve it and make it enter DCM easily.

### Enable

When the input voltage exceeds the under-voltage lockout (UVLO) threshold—typically 2.2V—the MP2143 is enabled by pulling the EN pin above 1.2V. Leaving the EN pin floating or grounded will disable the MP2143. There is an internal 1MΩ resistor from the EN pin to ground.

### Soft-Start/Stop

MP2143 has a built-in soft-start that ramps up the output voltage at a constant slew rate that avoids overshooting at startup. The soft-start time is typically about 1ms. When disabled, the MP2143 ramps down the internal reference voltage to allow the load to linearly discharge the output.

### Power GOOD Indicator

MP2143 has an open drain with 500kΩ pull-up resistor pin for power good (PG) indication. When the FB pin is within ±10% of regulation voltage (0.6V), the PG pin is pulled up to V<sub>IN</sub> by the internal resistor. If the FB pin voltage is outside the ±10% window, the PG pin is pulled to ground by an internal MOSFET. The MOSFET has a maximum R<sub>dson</sub> of less than 100Ω.

### Current limit

The MP2143 has a 4.8A current limit for the high side switch (HS-FET). When the HS-FET hits its current limit, the MP2143 enters hiccup mode until the current drops to prevent the inductor current from building and possibly damaging the components.

### Short Circuit and Recovery

The MP2143 also enters short-circuit protection (SCP) mode when it hits the current limit, and tries to recover from the short circuit by entering hiccup mode. In SCP, the MP2143 disables the output power stage, discharges a soft-start capacitor, and then enacts a soft-start procedure. If the short-circuit condition still holds after soft-start ends, the MP2143 repeats this operation until the short circuit ceases and output rises back to regulation level.

## APPLICATION INFORMATION

### COMPONENT SELECTION

#### Setting the Output Voltage

The external resistor divider sets the output voltage (see the Typical Application schematic on page 1). The feedback resistor R1 must account for both stability and dynamic response, and thus can not be too large or too small. Choose an R1 value between 120kΩ and 200kΩ. R2 is then given by:

$$R2 = \frac{R1}{\frac{V_{out}}{0.6} - 1}$$

The feedback circuit is shown as Figure 2.

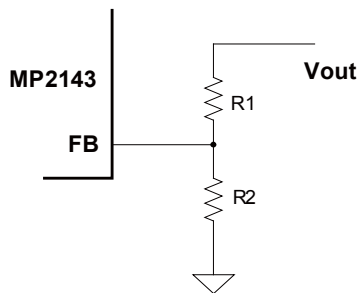

**Figure 2: Feedback Network**

Table 1 lists the recommended resistors values for common output voltages.

**Table 1: Resistor Values for Common Output Voltages**

V <sub>OUT</sub> (V)	R1 (kΩ)	R2 (kΩ)
1.0	200(1%)	300(1%)
1.2	200(1%)	200(1%)
1.8	200(1%)	100(1%)
2.5	200(1%)	63.2(1%)
3.3	200(1%)	44.2(1%)

#### Selecting the Inductor

A 0.82µH to 4.7µH inductor is recommended for most applications. For highest efficiency, choose an inductor with a DC resistance less than 15mΩ. For most designs, the inductance value can be derived from the following equation.

$$L_1 = \frac{V_{OUT} \times (V_{IN} - V_{OUT})}{V_{IN} \times \Delta I_L \times f_{OSC}}$$

Where ΔI<sub>L</sub> is the inductor ripple current.

Choose an inductor current to be approximately 30% of the maximum load current. The maximum inductor peak current is:

$$I_{L(MAX)} = I_{LOAD} + \frac{\Delta I_L}{2}$$

#### Selecting the Input Capacitor

The input current to the step-down converter is discontinuous, and requires a capacitor to supply the AC current to the step-down converter while maintaining the DC input voltage. Use low-ESR capacitors for the best performance. Ceramic capacitors with X5R or X7R dielectrics are highly recommended because of their low ESR values and small temperature coefficients. For most applications, a 10µF capacitor is sufficient. For higher output voltage, use 47µF to improve system stability.

Since the input capacitor absorbs the input switching current it requires an adequate ripple current rating. The RMS current in the input capacitor can be estimated by:

$$I_{C1} = I_{LOAD} \times \sqrt{\frac{V_{OUT}}{V_{IN}} \times \left(1 - \frac{V_{OUT}}{V_{IN}}\right)}$$

The worse case condition occurs at V<sub>IN</sub> = 2V<sub>OUT</sub>, where:

$$I_{C1} = \frac{I_{LOAD}}{2}$$

For simplification, choose an input capacitor whose RMS current rating greater than half of the maximum load current.

The input capacitor can be electrolytic, tantalum or ceramic. When using electrolytic or tantalum capacitors, use a small high-quality ceramic capacitor (0.1µF), placed as close to the IC as possible. When using ceramic capacitors, make sure that they have enough capacitance to prevent excessive voltage ripple at input. The input voltage ripple caused by capacitance can be estimated by:

$$\Delta V_{IN} = \frac{I_{LOAD}}{f_s \times C1} \times \frac{V_{OUT}}{V_{IN}} \times \left(1 - \frac{V_{OUT}}{V_{IN}}\right)$$

### Selecting the Output Capacitor

The output capacitor (C2) maintains the output DC voltage. Use ceramic capacitors. Low-ESR capacitors keep the output voltage ripple low. The output voltage ripple can be estimated by:

$$\Delta V_{OUT} = \frac{V_{OUT}}{f_s \times L_1} \times \left(1 - \frac{V_{OUT}}{V_{IN}}\right) \times \left(R_{ESR} + \frac{1}{8 \times f_s \times C2}\right)$$

Where L<sub>1</sub> is the inductor value and R<sub>ESR</sub> is the equivalent series resistance of the output capacitor.

Using ceramic capacitors, the impedance at the switching frequency is dominated by the capacitance. The output voltage ripple is mainly caused by the capacitance. For simplification, the output voltage ripple can be estimated by:

$$\Delta V_{OUT} = \frac{V_{OUT}}{8 \times f_s^2 \times L_1 \times C2} \times \left(1 - \frac{V_{OUT}}{V_{IN}}\right)$$

For tantalum or electrolytic capacitors, the ESR dominates the impedance at the switching frequency. For simplification, the output ripple can be approximated as:

$$\Delta V_{OUT} = \frac{V_{OUT}}{f_s \times L_1} \times \left(1 - \frac{V_{OUT}}{V_{IN}}\right) \times R_{ESR}$$

The characteristics of the output capacitor also affect the stability of the regulation system.

### TYPICAL APPLICATION CIRCUITS

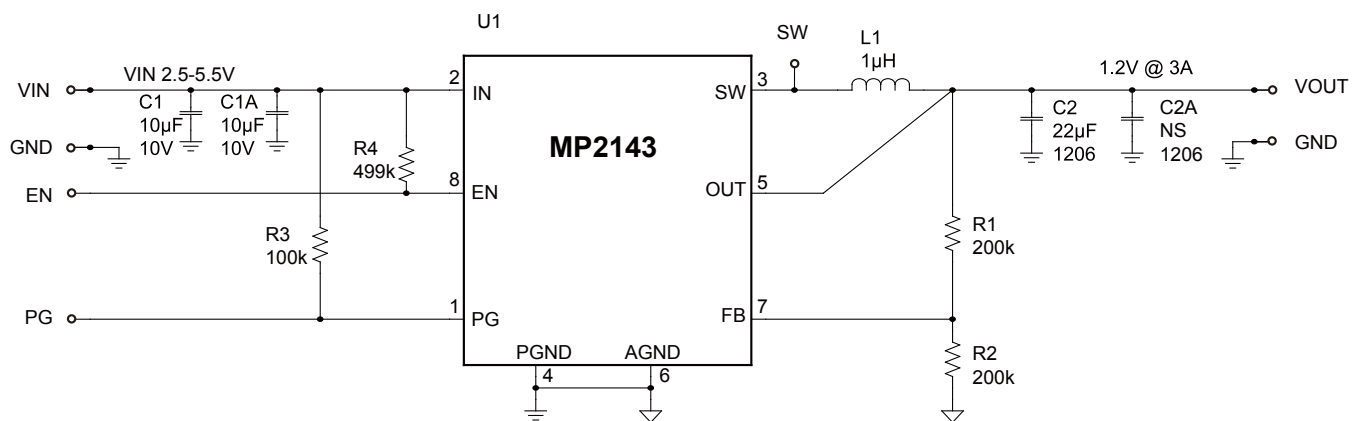
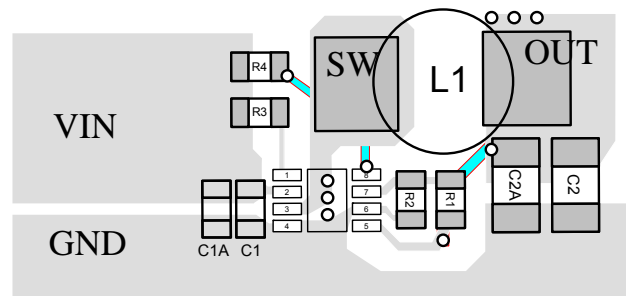

**Figure 4: MP2143 Typical Application Circuit**

### PCB Recommendation of MP2143

Proper layout of the switching power supplies is very important, and sometimes critical for proper operation. For high-frequency switching converters, poor layout could lead to poor line or load regulation and stability issues.

The high current paths (GND, VIN, and SW) should be placed very close to the device using short, direct, and wide traces. The input capacitor needs to be as close as possible to the VIN and GND pins. The external feedback resistors should be placed next to the FB pin. Keep the switching node SW short and away from the feedback network.



**Figure 3: Layout Recommendation**

## PACKAGE INFORMATION

### TSOT23-8

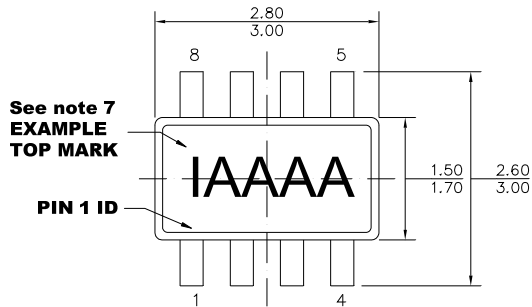

**TOP VIEW**

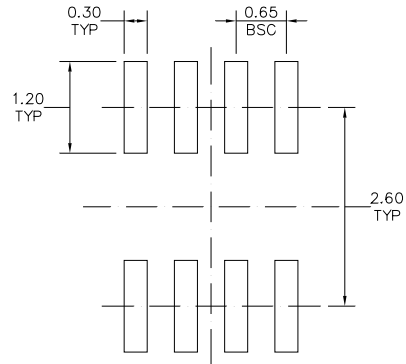

**RECOMMENDED LAND PATTERN**

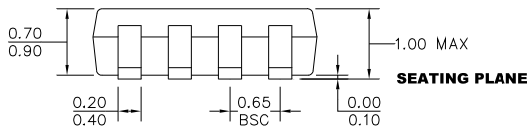

**FRONT VIEW**

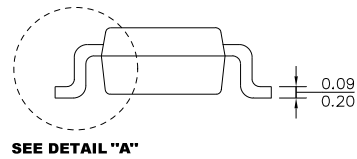

**SIDE VIEW**

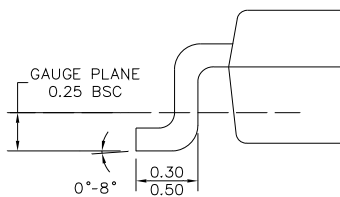

**DETAIL "A"**

### NOTE:

- 1) ALL DIMENSIONS ARE IN MILLIMETERS.
- 2) PACKAGE LENGTH DOES NOT INCLUDE MOLD FLASH, PROTRUSION OR GATE BURR.
- 3) PACKAGE WIDTH DOES NOT INCLUDE INTERLEAD FLASH OR PROTRUSION.
- 4) LEAD COPLANARITY (BOTTOM OF LEADS AFTER FORMING) SHALL BE 0.10 MILLIMETERS MAX.
- 5) JEDEC REFERENCE IS MO-193, VARIATION BA.
- 6) DRAWING IS NOT TO SCALE.
- 7) PIN 1 IS LOWER LEFT PIN WHEN READING TOP MARK FROM LEFT TO RIGHT, (SEE EXAMPLE TOP MARK)

**NOTICE:** The information in this document is subject to change without notice. Please contact MPS for current specifications. Users should warrant and guarantee that third party Intellectual Property rights are not infringed upon when integrating MPS products into any application. MPS will not assume any legal responsibility for any said applications.