

N-Channel Enhancement Mode MOSFET

TDM3548

DESCRIPTION

The TDM3548 uses advanced trench technology to provide excellent RDS(ON) and low gate charge. This device is suitable for use as a load switch or in PWM applications.

GENERAL FEATURES

- RDS(ON) < 11mΩ @ VGS=4.5V
RDS(ON) < 6.8mΩ @ VGS=10V
- High Power and current handling capability
- Lead free product is available
- Surface Mount Package

Application

- PWM applications
- Load switch
- Power management

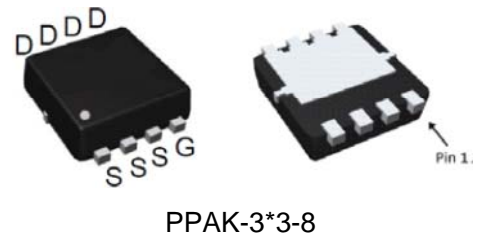
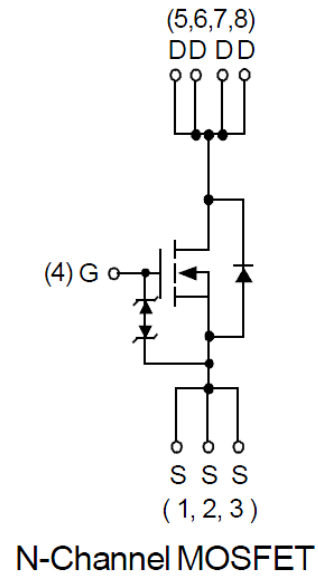

ABSOLUTE MAXIMUM RATINGS(T_A=25°C unless otherwise noted)

Parameter	Symbol	Limit	Unit
Drain-Source Voltage	V _{DS}	30	V
Gate-Source Voltage	V _{GS}	±20	V
Drain Current @ Continuous	I _D (T _c =25°C)	57	A
	I _D (T _c =100°C)	36	A
Drain Current @ Current-Pulsed (Note 1)	I _{DM} (T _c =25°C)	100	A
Maximum Power Dissipation	P _D (T _c =25°C)	31.3	W
	P _D (T _c =100°C)	12.5	
Drain Current @ Continuous	I _D (T _A =25°C)	13	A
	I _D (T _A =70°C)	10	A
Maximum Power Dissipation	P _D (T _A =25°C)	2.08	W
	P _D (T _A =70°C)	1.3	
Thermal Resistance,Junction-to-Ambient (Note 2)	R _{θJA} (t≤10s)	40	°C/W
	R _{θJA} (Steady State)	60	
Thermal Resistance,Junction-to-Case	R _{θJC} (Steady State)	4	°C/W
Maximum Operating Junction Temperature	T _J	150	°C
Storage Temperature Range	T _{STG}	-55 To 150	°C

ELECTRICAL CHARACTERISTICS ($T_A=25^{\circ}\text{C}$ unless otherwise noted)

Parameter	Symbol	Condition	Min	Typ	Max	Unit
OFF CHARACTERISTICS						
Drain-Source Breakdown Voltage	BV_{DSS}	$V_{GS}=0V, I_D=250\mu A$	30	-	-	V
Zero Gate Voltage Drain Current	I_{DSS}	$V_{DS}=24V, V_{GS}=0V$	-	-	1	μA
Gate-Body Leakage Current	I_{GSS}	$V_{GS}=\pm 20V, V_{DS}=0V$	-	-	± 10	μA
ON CHARACTERISTICS (Note 3)						
Gate Threshold Voltage	$V_{GS(th)}$	$V_{DS}=V_{GS}, I_D=250\mu A$	1.4	1.7	2.5	V
Drain-Source On-State Resistance	$R_{DS(on)}$	$V_{GS}=4.5V, I_D=10A$	-	8.5	11	$m\Omega$
		$V_{GS}=10V, I_D=15A$	-	5.6	6.8	$m\Omega$
DYNAMIC CHARACTERISTICS (Note 4)						
Input Capacitance	C_{iss}	$V_{DS}=15V, V_{GS}=0V, F=1.0MHz$	-	690	-	PF
Output Capacitance	C_{oss}		-	380	-	PF
Reverse Transfer Capacitance	C_{rss}		-	113	-	PF
SWITCHING CHARACTERISTICS (Note 4)						
Turn-on Delay Time	$t_{d(on)}$	$V_{DS}=15V, R_L=15\Omega, V_{GEN}=10V, R_G=1\Omega, I_D=1A$	-	10.8	-	nS
Turn-on Rise Time	t_r		-	8.6	-	nS
Turn-Off Delay Time	$t_{d(off)}$		-	18	-	nS
Turn-Off Fall Time	t_f		-	11.6	-	nS
Total Gate Charge	Q_g	$V_{DS}=15V, I_D=15A, V_{GS}=4.5V$	-	7	-	nC
Gate-Source Charge	Q_{gs}		-	1.4	-	nC
Gate-Drain Charge	Q_{gd}		-	4.1	-	nC
Body Diode Reverse Recovery Time	T_{rr}	$I_F=5A, di/dt=100A/\mu s$	-	23	-	nS
Body Diode Reverse Recovery Charge	Q_{rr}		-	10	-	nC
DRAIN-SOURCE DIODE CHARACTERISTICS						
Diode Forward Voltage (Note 3)	V_{SD}	$V_{GS}=0V, I_S=20A$	-	0.81	1.1	V

NOTES:

1. Pulse width limited by max. junction temperature.
2. $R_{\theta JA}$ steady state $t=100s$.
3. Pulse Test: Pulse Width $\leq 300\mu s$, Duty Cycle $\leq 2\%$.
4. Guaranteed by design, not subject to production testing

Typical Operating Characteristics

Power Dissipation

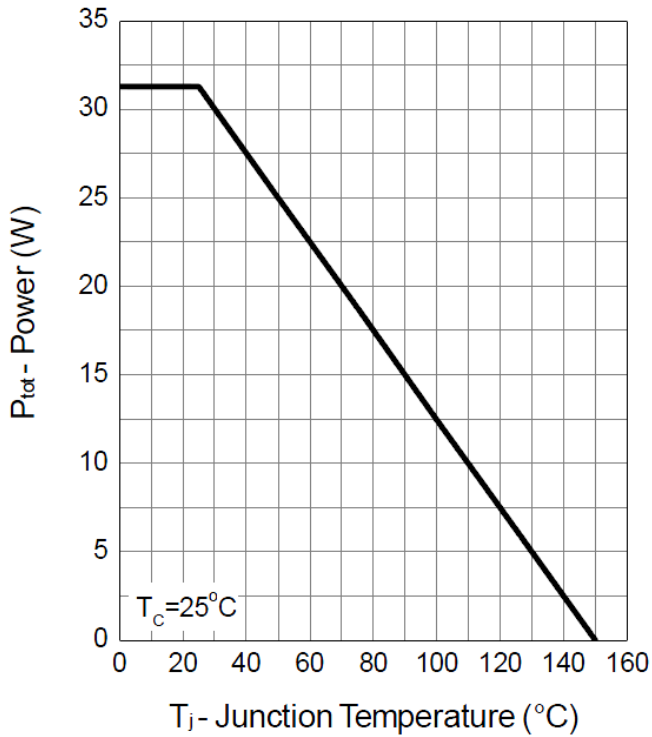

Drain Current

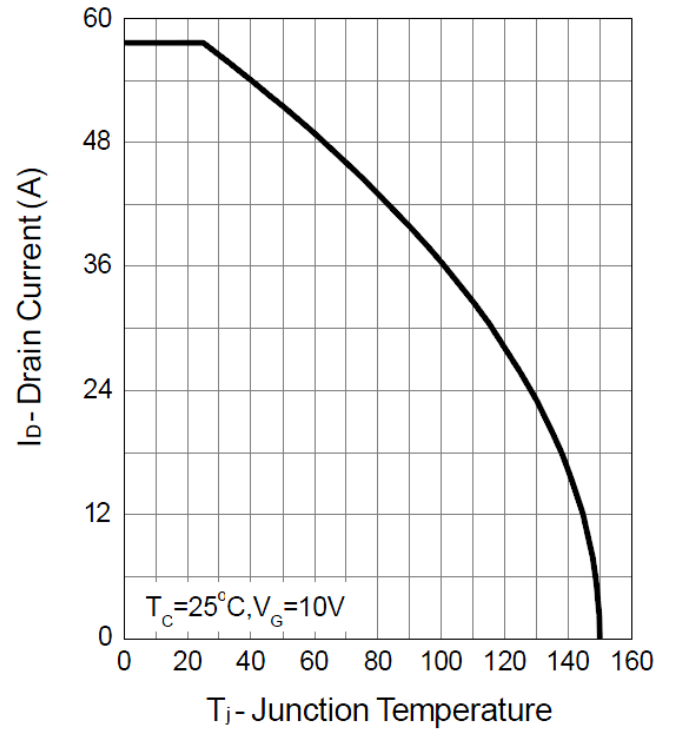

Safe Operation Area

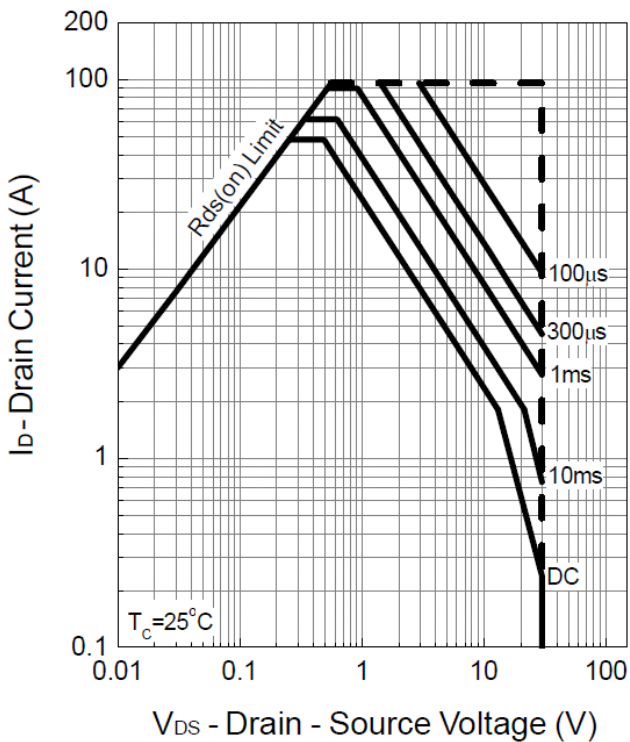

Thermal Transient Impedance

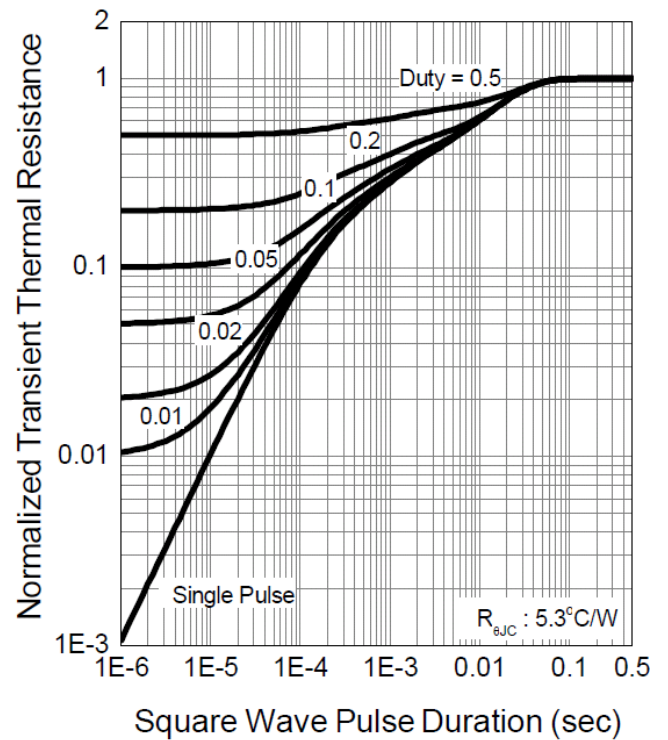

Typical Operating Characteristics(Cont.)

Safe Operation Area

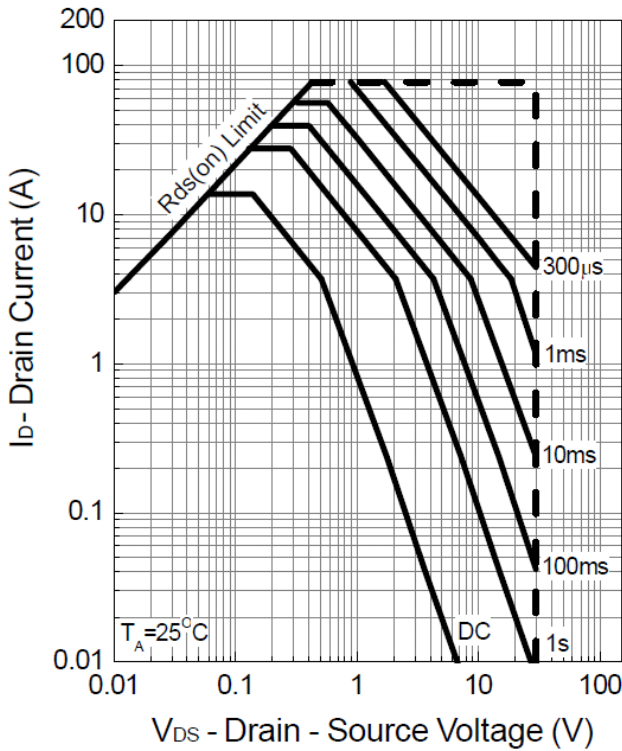

Thermal Transient Impedance

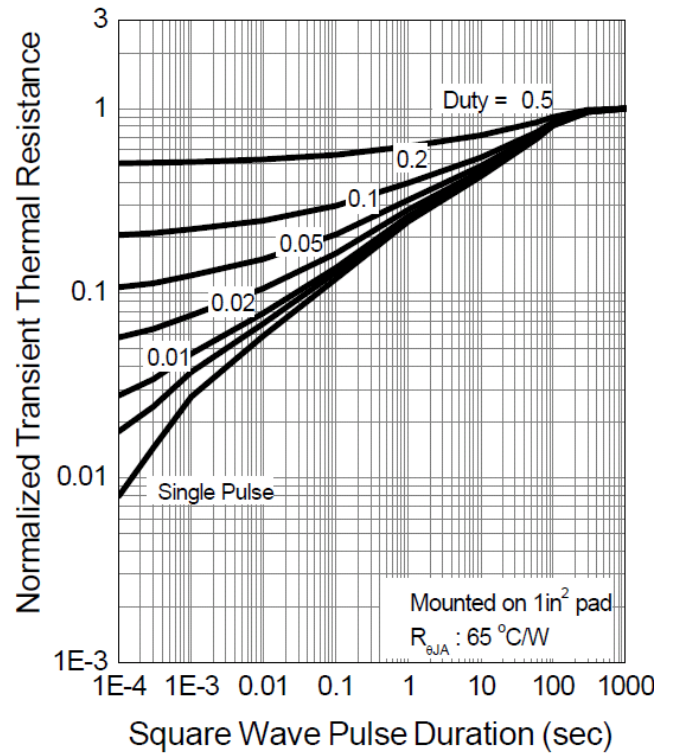

Output Characteristics

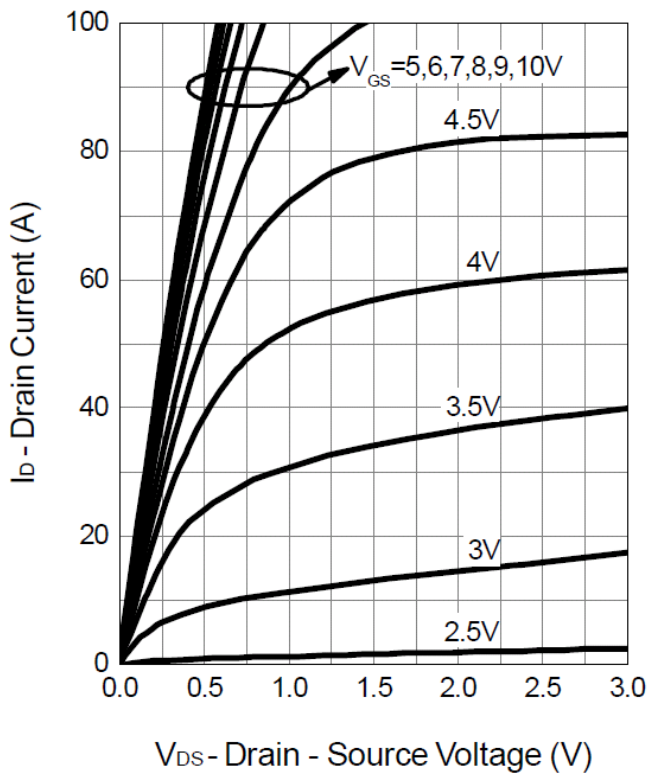

Drain-Source On Resistance

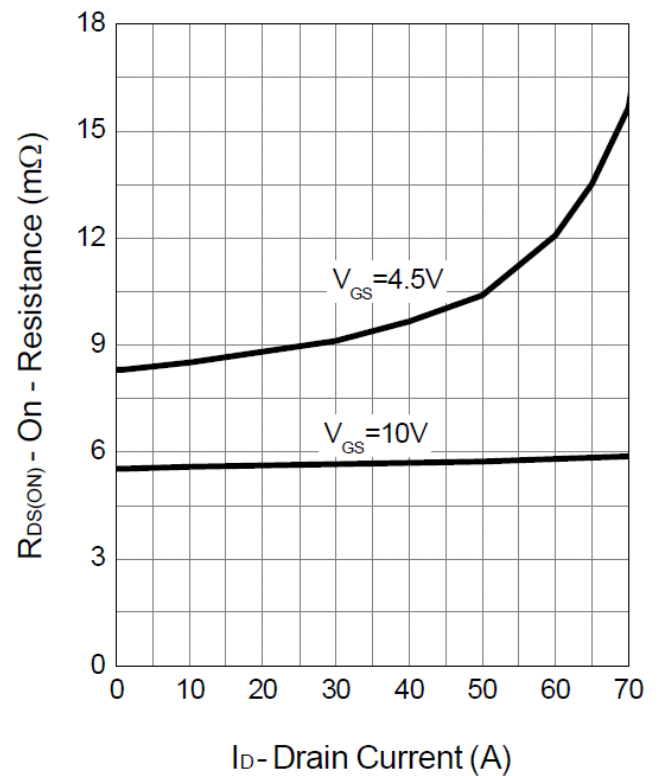

Typical Operating Characteristics (Cont.)

Gate-Source On Resistance

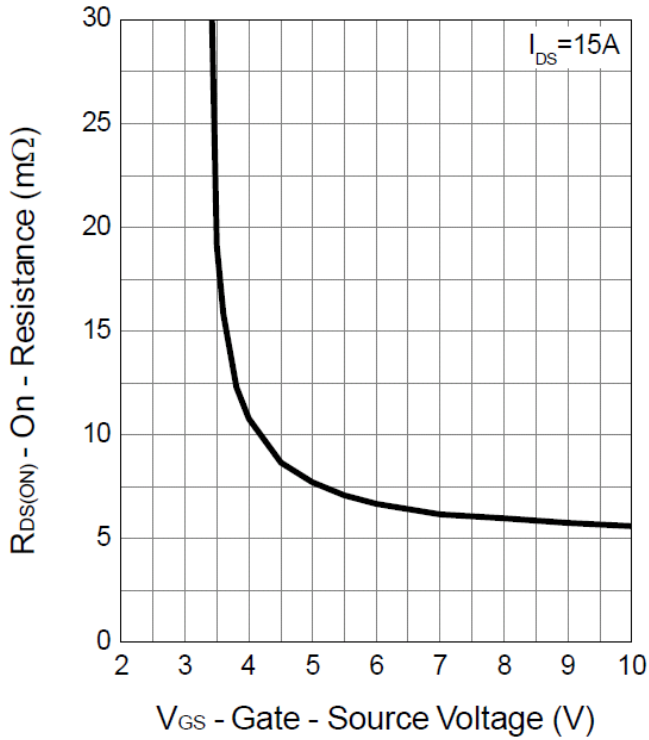

Gate Threshold Voltage

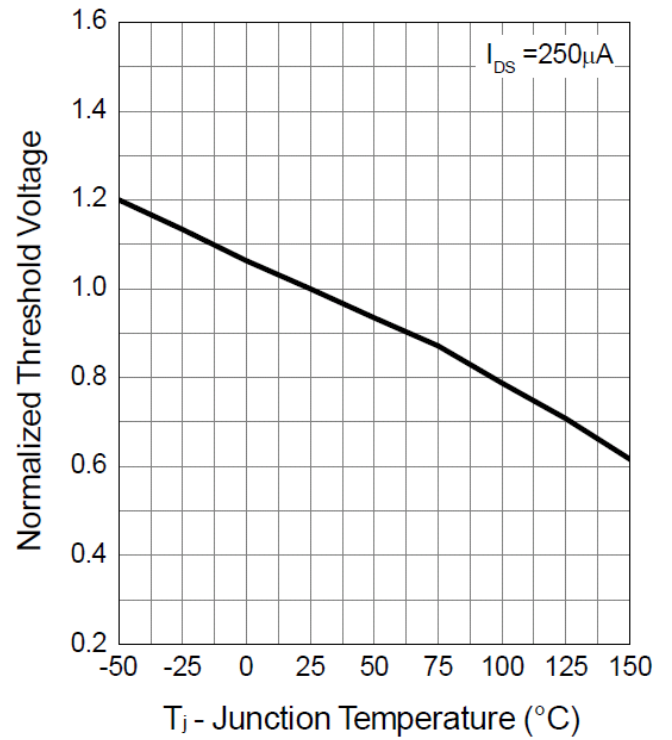

Drain-Source On Resistance

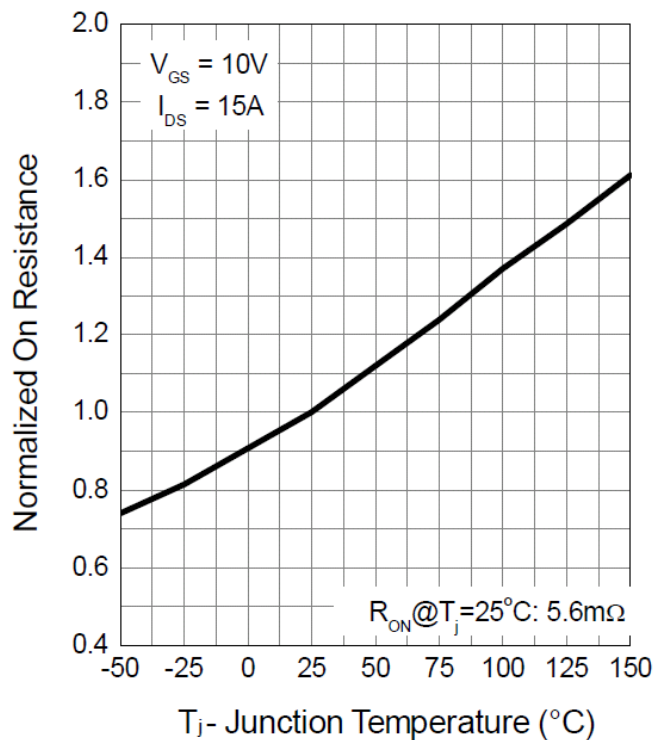

Source-Drain Diode Forward

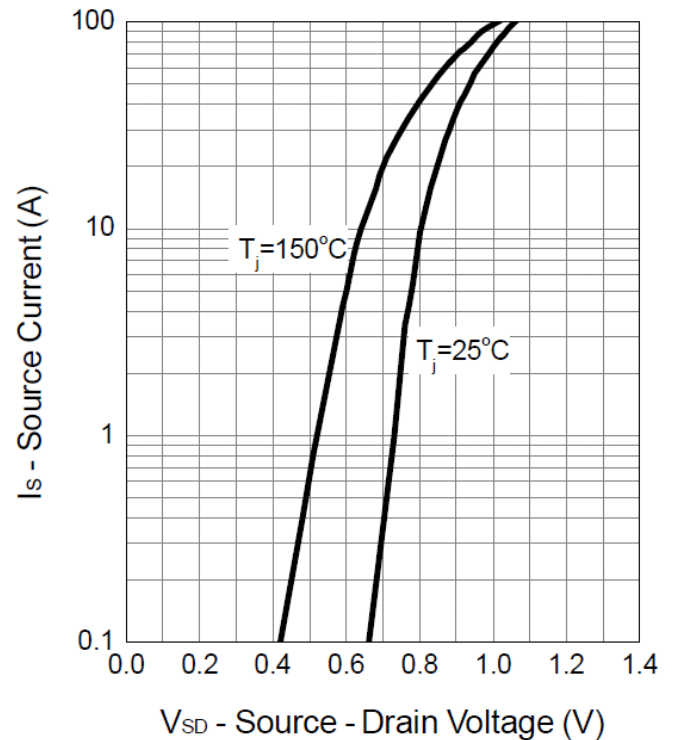

Typical Operating Characteristics (Cont.)

Capacitance

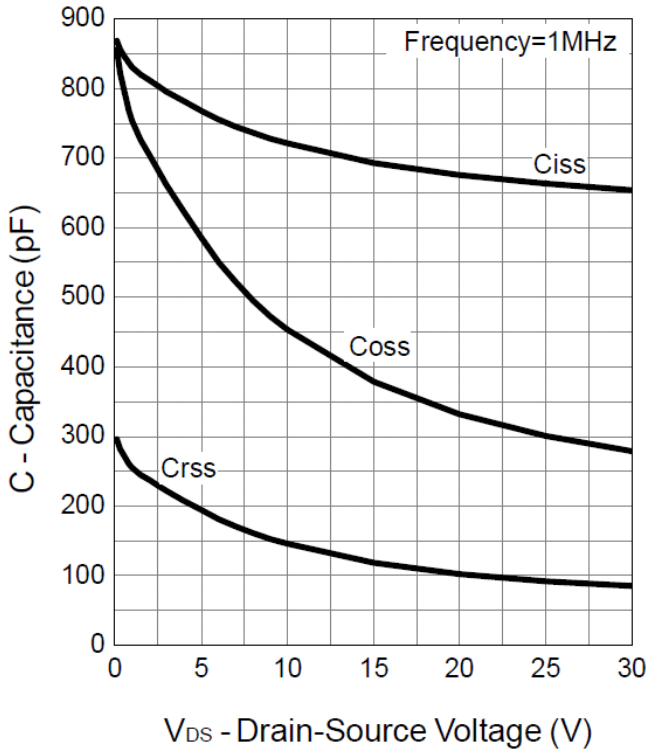

Gate Charge

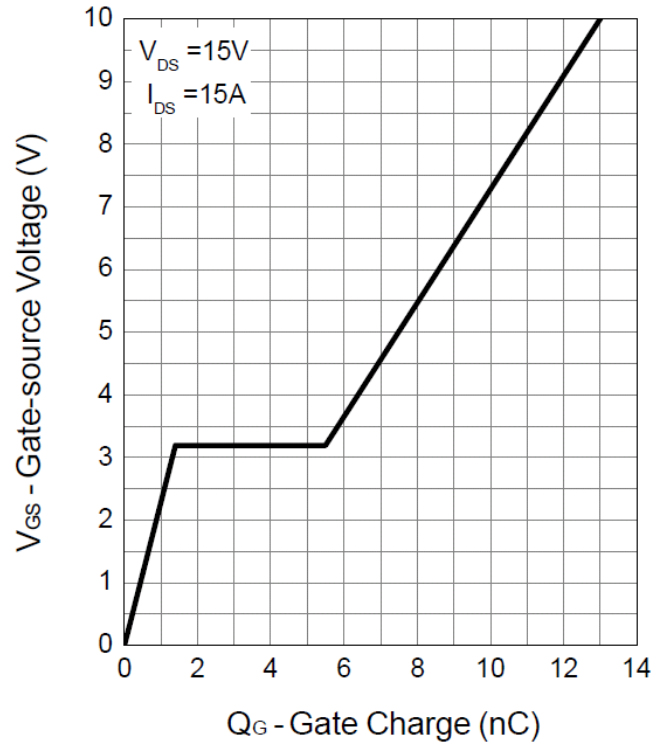

Transfer Characteristics

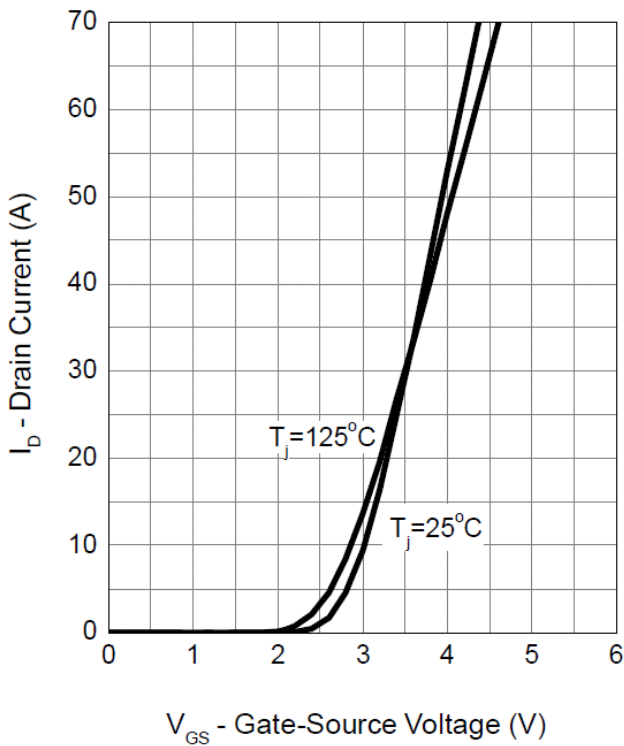

Package Information

PPAK-3*3-8 Package

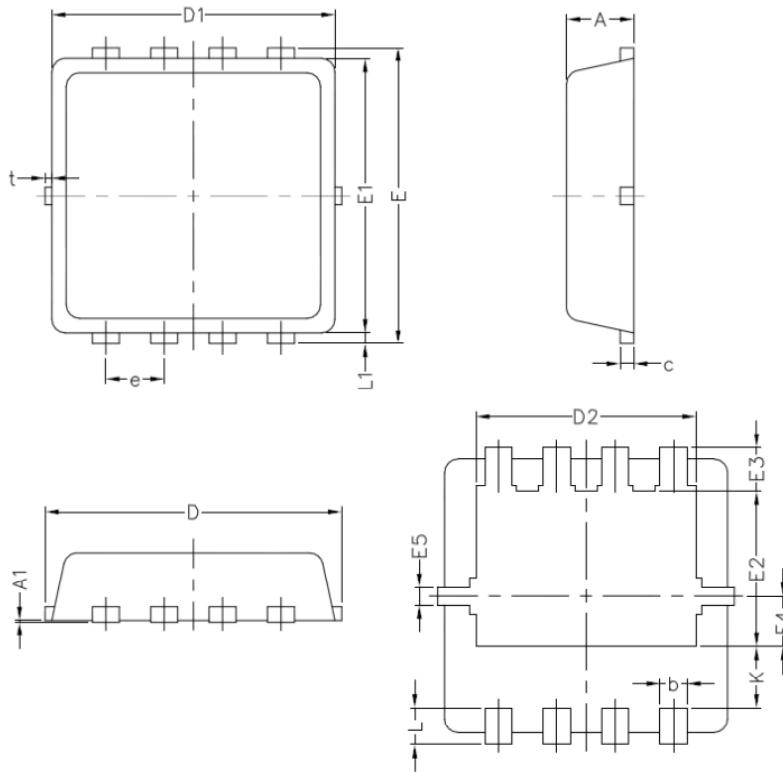

Symbol	PPAK-3*3-8(mm)		
	Min	Nom	Max
A	0.70	0.75	0.85
A1	/	/	0.05
b	0.20	0.30	0.40
c	0.10	0.152	0.25
D	3.15	3.3	3.45
D1	3.00	3.15	3.30
D2	2.25	2.45	2.65
E	3.15	3.30	3.45
E1	2.90	3.05	3.20
E2	1.54	1.74	1.94
E3	0.28	0.48	0.68
E4	0.37	0.57	0.77
E5	0.10	0.20	0.30
e	0.60	0.65	0.70
K	0.49	0.69	0.89
L	0.30	0.40	0.50
L1	0.06	0.125	0.20
t	/	/	0.13

Design Notes