

60V 3A 150kHz Step-Down Voltage Regulator

GENERAL DESCRIPTION

The LM2596HV series of regulators are monolithic integrated circuits that provide all the active functions for a step-down (buck) switching regulator, capable of driving a 3A load with excellent line and load regulation. These devices are available in fixed output voltages of 3.3V, 5V, 12V, and an adjustable output version.

Available in a standard 5-lead TO-220 package, 5-lead TO-263 surface mount package and SOP-8 package.

External shutdown is included, featuring typically 30 μ A standby current. The output switch includes cycle-by-cycle current limiting, as well as thermal shutdown, and protection from output short for full protection under fault conditions.

FEATURES

- 3.3V, 5V, 12V, and adjustable output versions
- Adjustable version output voltage range, 1.2V to 57V
- $\pm 4\%$ maximum over line and load conditions
- Available in TO-220 and TO-263 packages and SOP-8 (for $I_{load} < 2A$)
- Guaranteed 3A output load current
- Input voltage range up to 60V
- Requires only 4 external components
- Excellent line and load regulation specifications
- 150 kHz fixed frequency internal oscillator
- Low power standby mode, I_{stb} typically 30 μ A
- High efficiency
- Thermal shutdown and current limit protection
- Output short protection by reduction of frequency by 3 times.

APPLICATIONS

- Simple high-efficiency step-down (buck) regulator
- On-card switching regulators
- Efficient pre-regulator for linear regulators

PIN CONFIGURATION

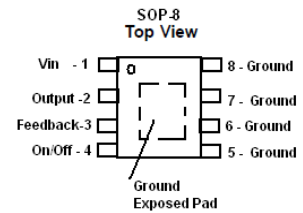
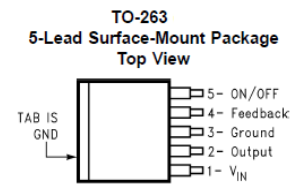
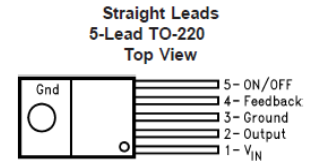

PIN ASSIGNMENT

Pin	SOP-8 (for $I_{load} < 2A$)	Pin	TO-220, TO-263
1	Vin	1	Vin
2	Output	2	Output
3	FB	3	Gnd
4	On/Off	4	FB
5 to 8	Gnd	5	On/Off

Typical Application (Fixed Output Voltage Versions)

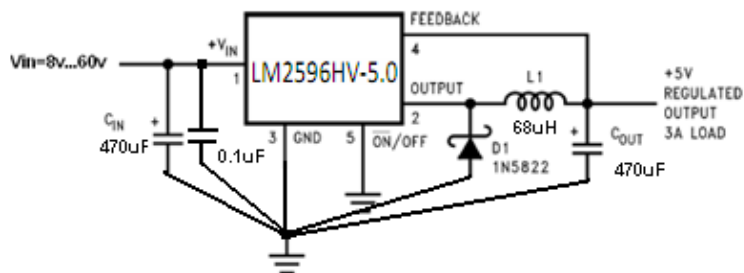

ABSOLUTE MAXIMUM RATINGS

Parameter	Symbol	Ratings	Unit
Maximum supply voltage	V_{IN}	63	V
ON/OFF Pin input voltage	$V_{ON/OFF}$	-0.3 to 60, $\leq V_{in}$	V
FB (Feedback) pin voltage	V_{FB}	-0.3 to 25, $\leq V_{in}$	V
Output voltage to GND	V_{OUT}	-1	V
Power dissipation	P_D	Internally limited	W
Minimum ESD rating HBM (C=100pF, R=1.5k)	ESD	2.0	kV
Maximum junction temperature	$T_{J,max}$	150°C	°C

RECOMMENDED OPERATING CONDITIONS

Parameter	Symbol	Ratings	Unit
Temperature range	T_J	-40°C $\leq T_J \leq$ +125°C	°C
Supply voltage	V_{op}	4.5 to 60	V
I_{LOAD}	I_{LOAD}	$I_{LOAD} \leq 3.0$	A

ELECTRICAL CHARACTERISTICS

Unless specified otherwise, $V_{IN}=12V$ for the 3.3V, 5V and adjustable versions, $I_{LOAD}=0.5A$, $V_{IN}=18V$ for 12V version.

The * denotes the specifications, which apply over full operating temperature range $T_J = -40$ to +125°C.

Parameter	Symbol	Conditions	*	Min	Typ	Max	Unit	
SYSTEM PARAMETERS Test Circuit Figure 1								
Output voltage	LM2596HV-3.3	V_{OUT}	$5.5V \leq V_{IN} \leq 60V, 0.2A \leq I_{LOAD} \leq 3A$		3.185	3.300	3.432	V
				*	3.152		3.465	
	LM2596HV-5.0		$8V \leq V_{IN} \leq 60V, 0.2A \leq I_{LOAD} \leq 3A$		4.825	5.00	5.20	V
				*	4.775		5.25	
	LM2596HV-12		$15V \leq V_{IN} \leq 60V, 0.2A \leq I_{LOAD} \leq 3A$		11.58	12.00	12.48	V
				*	11.46		12.60	
	LM2596HV-ADJ		$8V \leq V_{IN} \leq 60V, 0.2A \leq I_{LOAD} \leq 3A$		1.193	1.230	1.273	V
				*	1.180		1.285	
Line Regulation	Line Reg	$8 \leq V_{IN} \leq 60V, I_{LOAD} = 0.2A$			0.3		%	
Load Regulation	Load Reg	$10mA \leq I_{LOAD} \leq 3A, V_{IN} = 12V$			0.3		%	
Efficiency	LM2596HV-3.3	η	$V_{IN}=12V, I_{LOAD}=3A$		77		%	
	LM2596HV-5.0				79			
	LM2596HV-12				83			
	LM2596HV-ADJ				79			
DEVICE PARAMETERS								
Quiescent current	I_Q	$V_{FB}=12V$ force driver off			5	8	mA	
Feedback bias current	I_{FB}	$V_{FB}=1.3V$ (Adjustable version only)		-250	-70		nA	
			*	-450				
Shutdown supply current	I_{STB}	$V_{ON/OFF}=5V, V_{IN}=60V$			30	220	μA	
			*			280		
Oscillator frequency	F_{OSC}			133	150	168	kHz	
			*	120		180		
Oscillator frequency of Short Circuit Protect (SCP)	F_{SCP}	When $V_{OUT}<40\%$ from nominal, $I_{OUT}=CL$			50		kHz	
Max. duty cycle	$DC_{(Max)}$	$V_{FB}=0V$ force driver on	*	100			%	
Min. duty cycle	$DC_{(Min)}$	$V_{FB}=12V$ force driver off ($V_{FB}=15V$ for -12V version)	*			0	%	

Current limit	CL	Peak current. No outside circuit. $V_{FB}=0V$		4.1	5.3	6.7	A
			*	3.8		7.0	
Saturation voltage	V_{SAT}	$I_{OUT}=3A$. No outside circuit. $V_{FB}=0V$			1.35	1.50	V
			*			1.70	
Output leakage current	I_L	$V_{OUT}=0V$. No outside circuit. $V_{FB}=12V$		-300	-50		μA
Output leakage current	I_{L1}	$V_{OUT}=-1V$. No outside circuit. $V_{FB}=12V$		-30	-3		mA
ON/OFF input threshold	V_{TH}		*	0.6	1.3	2.0	V
ON/OFF input current	I_H	$V_{ON/OFF}=2.5V$		-5	-0.1	5	μA
ON/OFF input current	I_L	$V_{ON/OFF}=0.5V$		-1	-0.01	1	μA
Thermal shutdown temperature	T_{SD}	T_J			160		$^{\circ}C$

BLOCK DIAGRAM

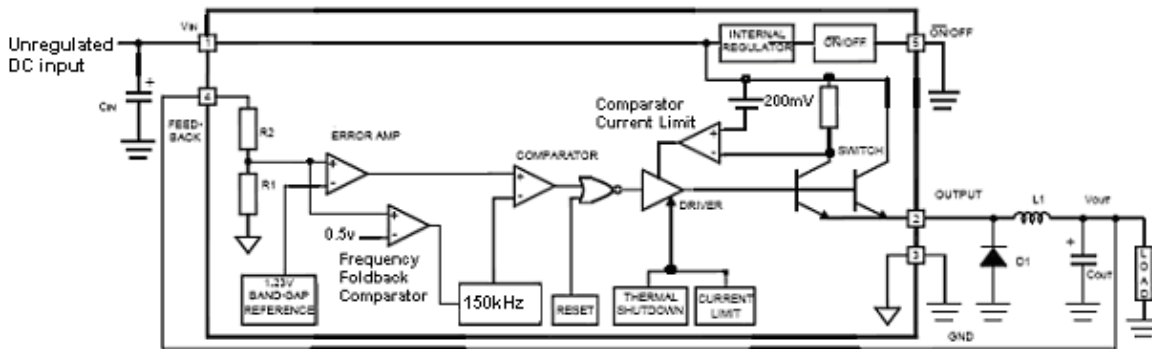

For ADJ Version
R1 = Open, R2 = 0 Ω

TEST CIRCUIT AND LAYOUT GUIDELINES

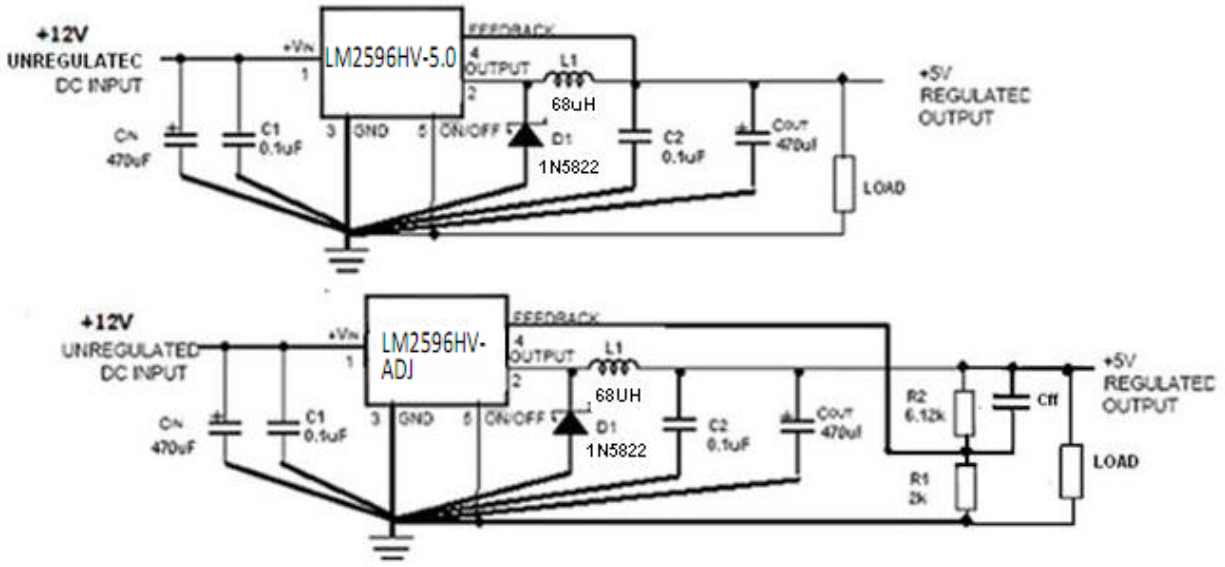

$V_{out} = V_{ref} * (1 + R2/R1)$, where $V_{ref} = 1.23V$; $R1$ between $1k$ and $5k$.

FIGURE 1.

For minimal inductance and ground loops, the wires indicated by **heavy lines** should be **wide printed circuit traces** and **kept as short as possible**. Keep the FEEDBACK wiring away from the inductor flux.

$C_{ff} \sim 1$ to $10nF$ – as option.

TYPICAL CHARACTERISTICS

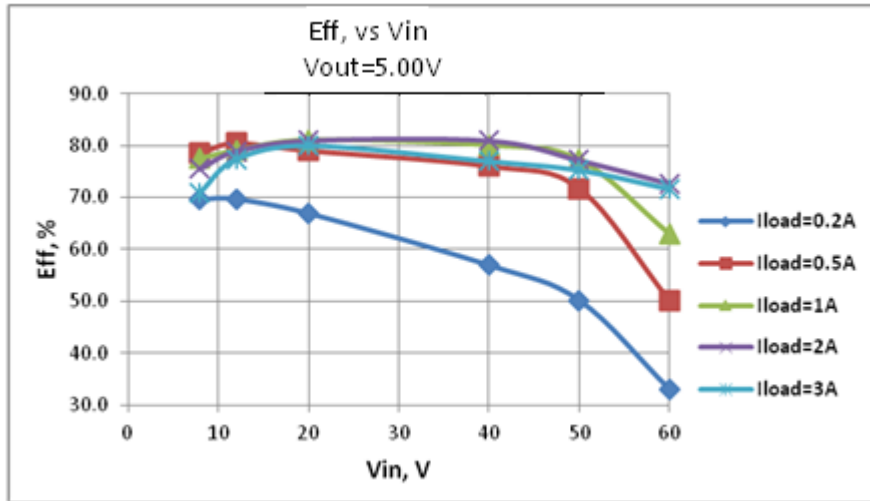

Fig.1. Eff, vs Vin

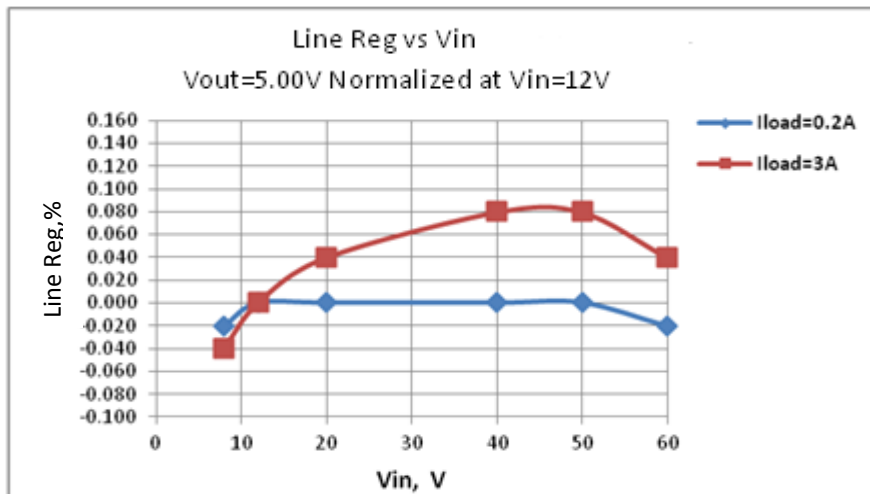

Fig.2. Line Reg vs Vin

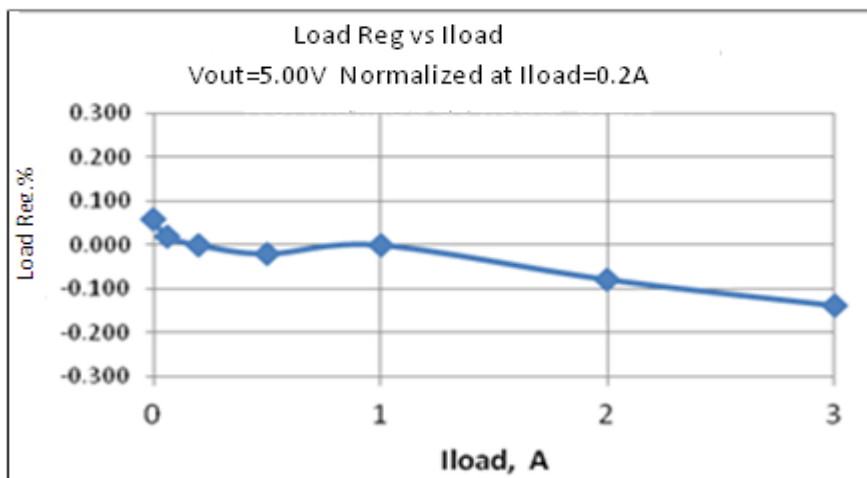

Fig.3. Load Reg vs Iload

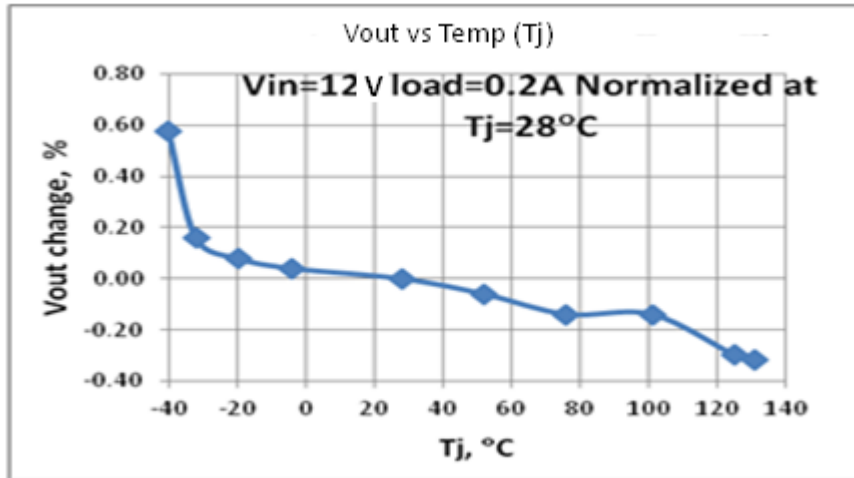

Fig.4. Vout vs Temp (Tj)

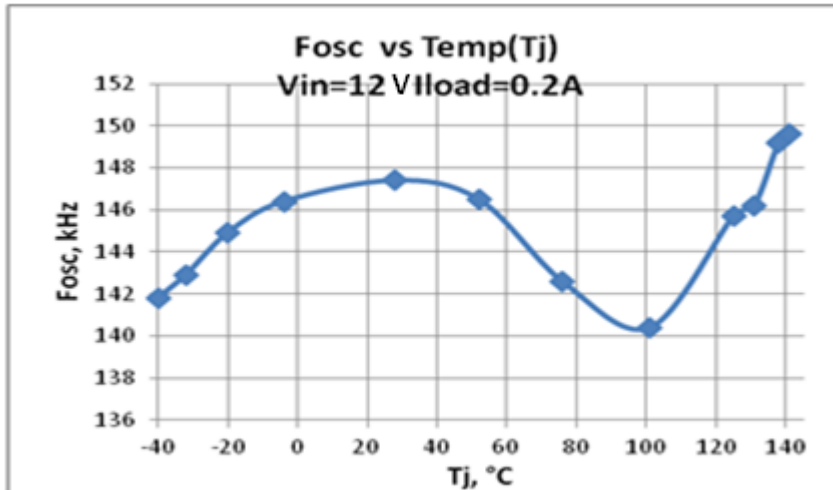

Fig.5. Fosc vs Temp (Tj)

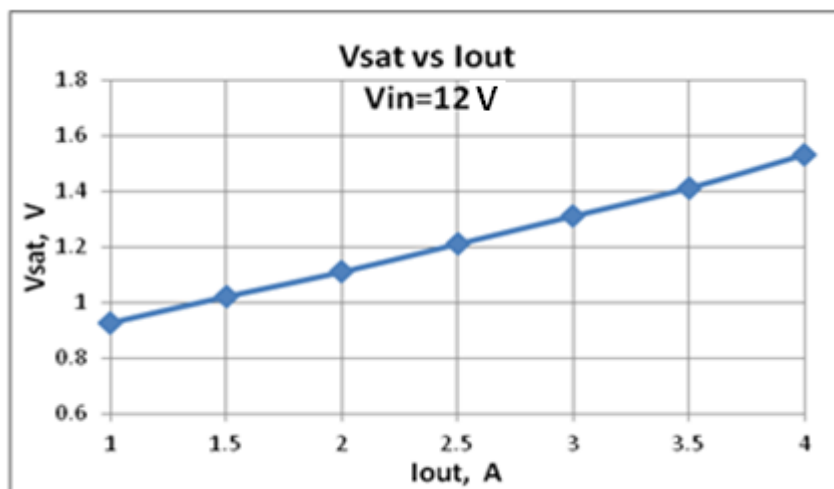

Fig.6. Vsat vs Iout

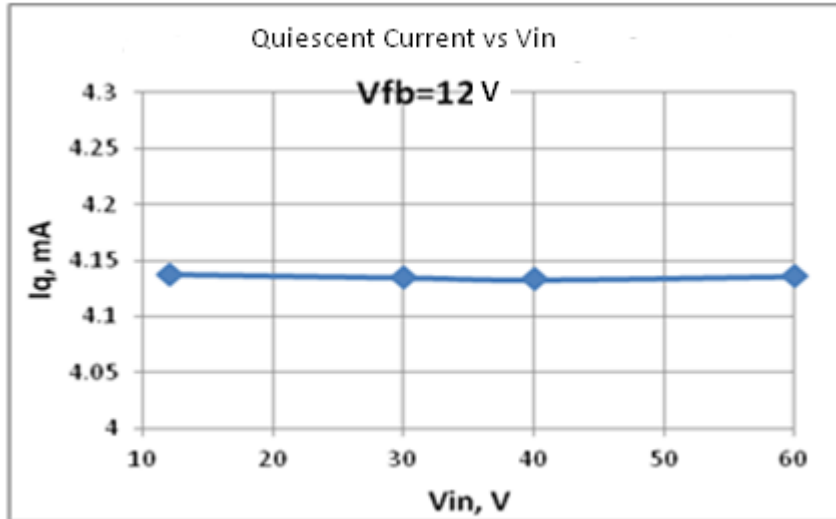

Fig.7. Quiescent Current vs Vin

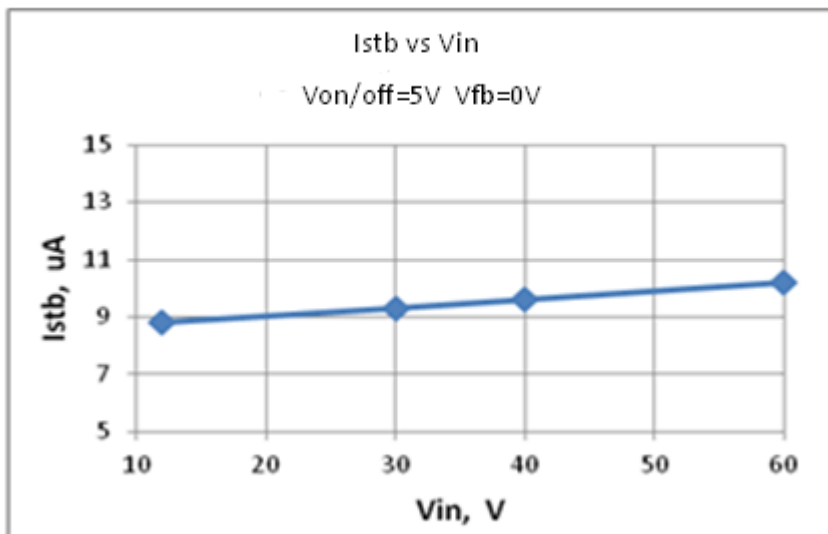

Fig.8. Istb vs Vin