

Product Summary

$V_{(BR)DSS}$	$R_{DS(ON)}$ max	I_D max $T_A = 25^\circ\text{C}$
30V	11m Ω @ $V_{GS} = 10\text{V}$	10.5A
	15m Ω @ $V_{GS} = 4.5\text{V}$	9.2A

Features and Benefits

- Low $R_{DS(ON)}$ – ensures on state losses are minimized
- Small form factor thermally efficient package enables higher density end products
- Occupies just 33% of the board area occupied by SO-8 enabling smaller end product
- "Green" component and RoHS compliant (Note 1)
- Qualified to AEC-Q101 Standards for High Reliability

Description and Applications

This MOSFET has been designed to minimize the on-state resistance ($R_{DS(on)}$) and yet maintain superior switching performance, making it ideal for high efficiency power management applications.

- Backlighting
- Power Management Functions
- DC-DC Converters

Mechanical Data

- Case: POWERDI®3333-8
- Case Material: Molded Plastic, "Green" Molding Compound. UL Flammability Classification Rating 94V-0
- Moisture Sensitivity: Level 1 per J-STD-020
- Terminal Connections Indicator: See diagram
- Terminals: Finish — NiPdAu over Copper leadframe. Solderable per MIL-STD-202, Method 208
- Weight: 0.072 grams (approximate)

POWERDI®3333-8

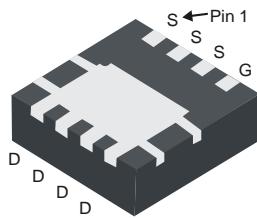

Bottom View

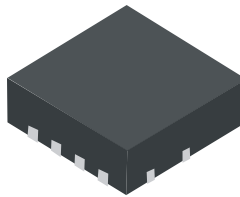

Top View

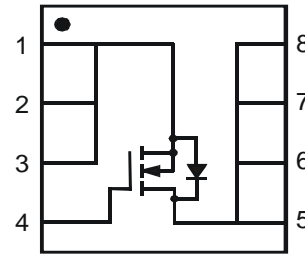

Top View
Internal Schematic

Ordering Information (Note 2)

Part Number	Case	Packaging
DMG7430LFG-7	POWERDI®3333-8	2000/Tape & Reel
DMG7430LFG-13	POWERDI®3333-8	3000/Tape & Reel

- Notes: 1. EU Directive 2002/95/EC (RoHS) & 2011/65/EU (RoHS 2). All applicable RoHS exemptions applied.
2. For packaging details, go to our website at <http://www.diodes.com>.

Marking Information

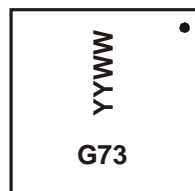

- G73 = Product Type Marking Code
- YYWW = Date Code Marking
- YY = Last digit of year (ex: 11 = 2011)
- WW = Week code (01 ~ 53)

Maximum Ratings @T_A = 25°C unless otherwise specified

Characteristic	Symbol	Value	Units	
Drain-Source Voltage	V _{DSS}	30	V	
Gate-Source Voltage	V _{GSS}	±20	V	
Continuous Drain Current (Note 4) V _{GS} = 10V	I _D	T _A = 25°C T _A = 70°C	10.5 8.5	A
		t < 10s	T _A = 25°C T _A = 70°C	14 11
Pulsed Drain Current (10µs pulse, duty cycle = 1%)	I _{DM}	90	A	
Maximum Continuous Body Diode Forward Current (Note 4)	I _S	3.0	A	
Avalanche Current (Note 5) L = 0.1mH	I _{AR}	22	A	
Repetitive Avalanche Energy (Note 5) L = 0.1mH	E _{AR}	24	mJ	

Thermal Characteristics @T_A = 25°C unless otherwise specified

Characteristic	Symbol	Value	Units	
Total Power Dissipation (Note 3)	P _D	Steady state	0.9	W
		t < 10s	1.5	
Thermal Resistance, Junction to Ambient (Note 3)	R _{θJA}	Steady state	142	°C/W
		t < 10s	78	
Total Power Dissipation (Note 4)	P _D	Steady state	2.2	W
		t < 10s	3.5	
Thermal Resistance, Junction to Ambient (Note 4)	R _{θJA}	Steady state	59	°C/W
		t < 10s	33	
Thermal Resistance, Junction to Case (Note 4)	R _{θJC}	11		
Operating and Storage Temperature Range	T _J , T _{STG}	-55 to +150	°C	

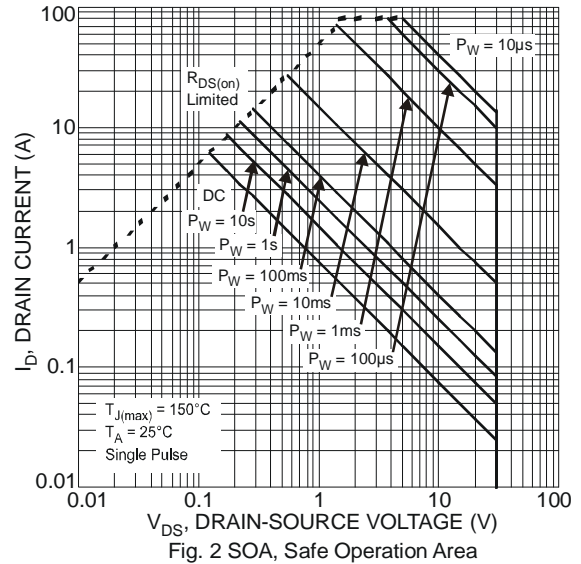
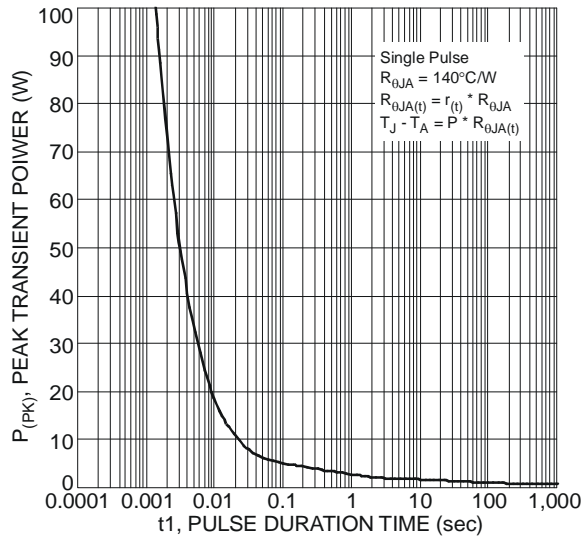

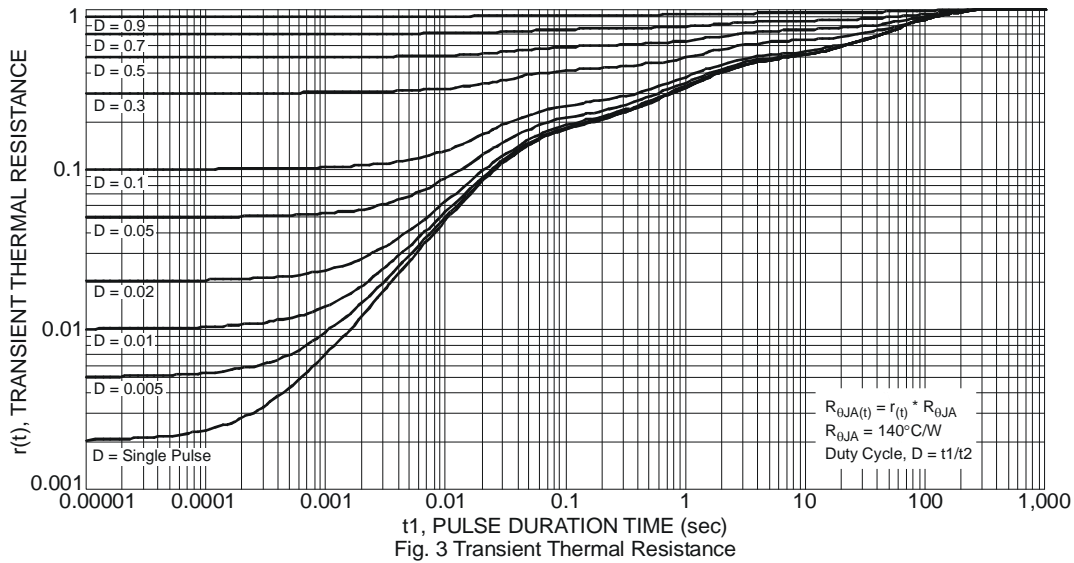

Electrical Characteristics $T_A = 25^\circ\text{C}$ unless otherwise specified

Characteristic	Symbol	Min	Typ	Max	Unit	Test Condition
OFF CHARACTERISTICS (Note 6)						
Drain-Source Breakdown Voltage	BV_{DSS}	30	-	-	V	$V_{GS} = 0V, I_D = 250\mu A$
Zero Gate Voltage Drain Current	I_{DSS}	-	-	1	μA	$V_{DS} = 30V, V_{GS} = 0V$
Gate-Source Leakage	I_{GSS}	-	-	± 100	nA	$V_{GS} = \pm 20V, V_{DS} = 0V$
ON CHARACTERISTICS (Note 6)						
Gate Threshold Voltage	$V_{GS(th)}$	1.4	-	2.5	V	$V_{DS} = V_{GS}, I_D = 250\mu A$
Static Drain-Source On-Resistance	$R_{DS(ON)}$	-	7	11	m Ω	$V_{GS} = 10V, I_D = 20A$
		-	11	15		$V_{GS} = 4.5V, I_D = 20A$
Forward Transfer Admittance	$ Y_{fs} $	-	74	-	S	$V_{DS} = 5V, I_D = 20A$
Diode Forward Voltage	V_{SD}	-	0.75	1.0	V	$V_{GS} = 0V, I_S = 1A$
DYNAMIC CHARACTERISTICS (Note 7)						
Input Capacitance	C_{iss}	-	1281	-	pF	$V_{DS} = 15V, V_{GS} = 0V, f = 1.0MHz$
Output Capacitance	C_{oss}	-	145	-	pF	
Reverse Transfer Capacitance	C_{rss}	-	125	-	pF	
Gate resistance	R_g	-	1.2	-	Ω	$V_{DS} = 0V, V_{GS} = 0V, f = 1.0MHz$
Total Gate Charge ($V_{GS} = 4.5V$)	Q_g	-	12.5	-	nC	
Total Gate Charge ($V_{GS} = 10V$)	Q_g	-	26.7	-	nC	
Gate-Source Charge	Q_{gs}	-	3.6	-	nC	
Gate-Drain Charge	Q_{gd}	-	4.4	-	nC	
Turn-On Delay Time	$t_{D(on)}$	-	5.2	-	ns	$V_{DD} = 15V, V_{GS} = 10V, R_L = 1.25\Omega, R_G = 3\Omega,$
Turn-On Rise Time	t_r	-	21.2	-	ns	
Turn-Off Delay Time	$t_{D(off)}$	-	22.3	-	ns	
Turn-Off Fall Time	t_f	-	5.1	-	ns	
Reverse Recovery Time	T_{rr}	-	8.5	-	ns	
Reverse Recovery Charge	Q_{rr}	-	7.0	-	nC	$I_F = 12A, di/dt = 500A/\mu s$

- Notes:
- Device mounted on FR-4 substrate PC board, 2oz copper, with minimum recommended pad layout.
 - Device mounted on FR-4 substrate PC board, 2oz copper, with 1inch square copper plate.
 - I_{AR} and E_{AR} rating are based on low frequency and duty cycles to keep $T_J = 25^\circ\text{C}$
 - Short duration pulse test used to minimize self-heating effect.
 - Guaranteed by design. Not subject to product testing.

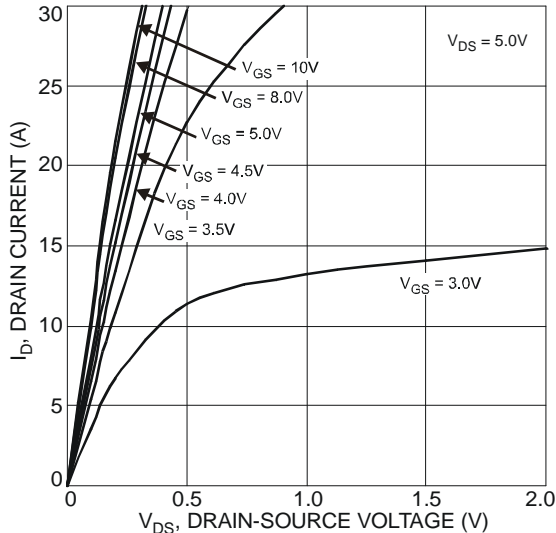

Fig. 4 Typical Output Characteristic

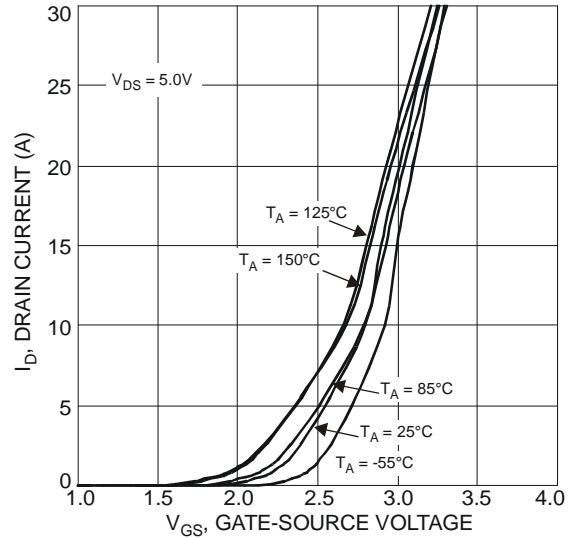

Fig. 5 Typical Transfer Characteristics

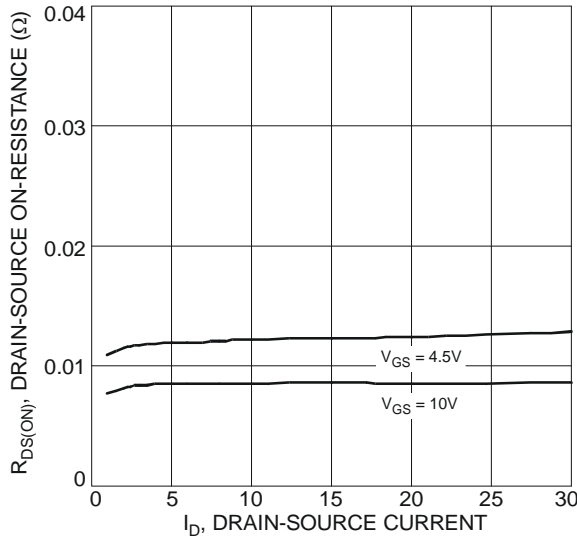

Fig. 6 Typical On-Resistance vs. Drain Current and Gate Voltage

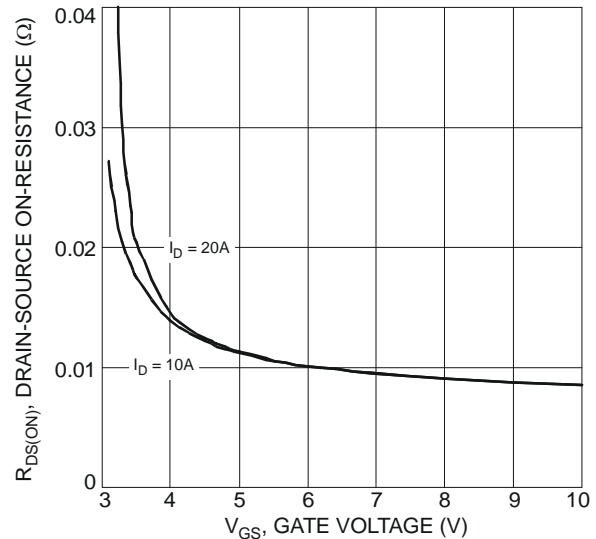

Fig. 7 Typical On-Resistance vs. Gate Voltage

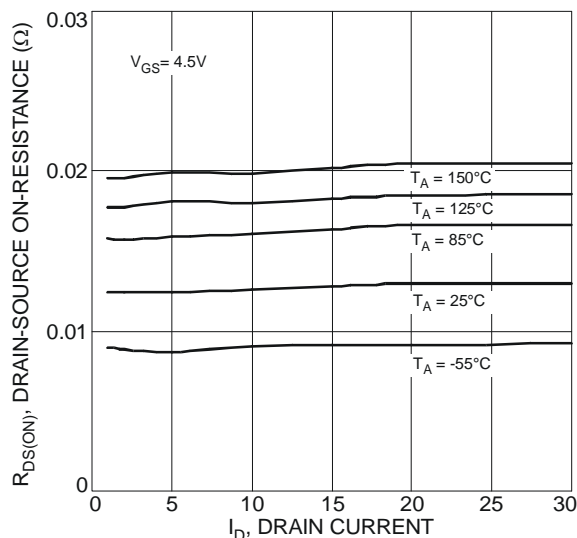

Fig. 8 Typical On-Resistance vs. Drain Current and Temperature

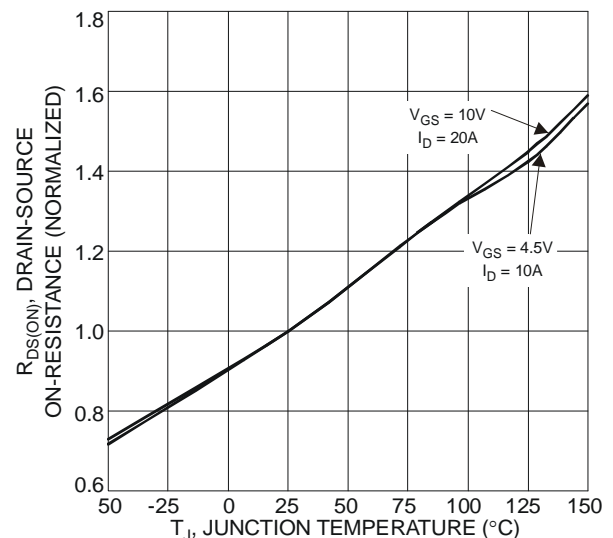

Fig. 9 On-Resistance Variation with Temperature

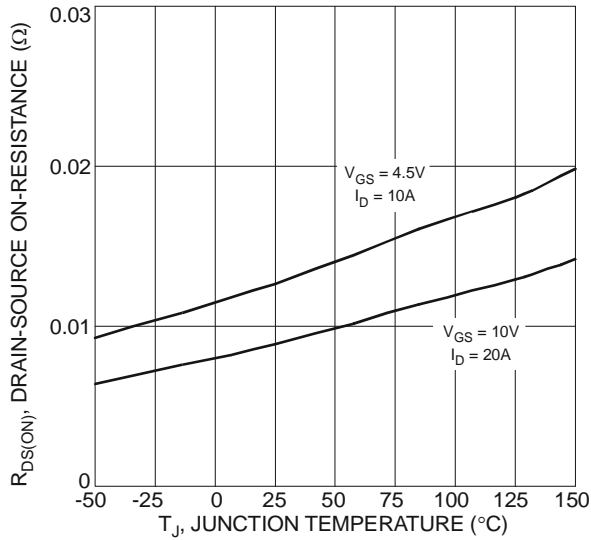

Fig. 10 On-Resistance Variation with Temperature

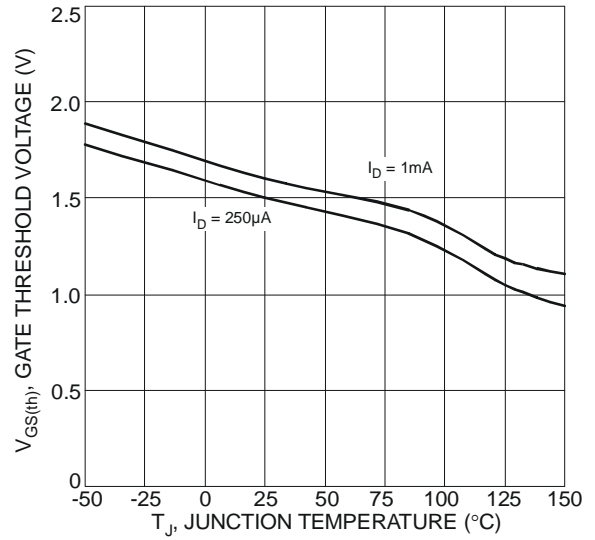

Fig. 11 Gate Threshold Variation vs. Ambient Temperature

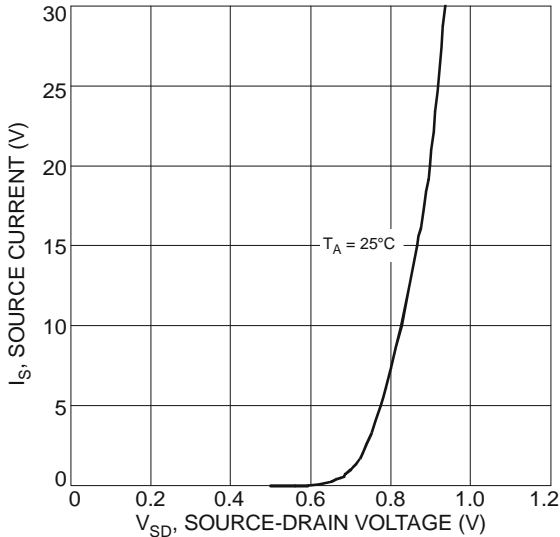

Fig. 12 Diode Forward Voltage vs. Current

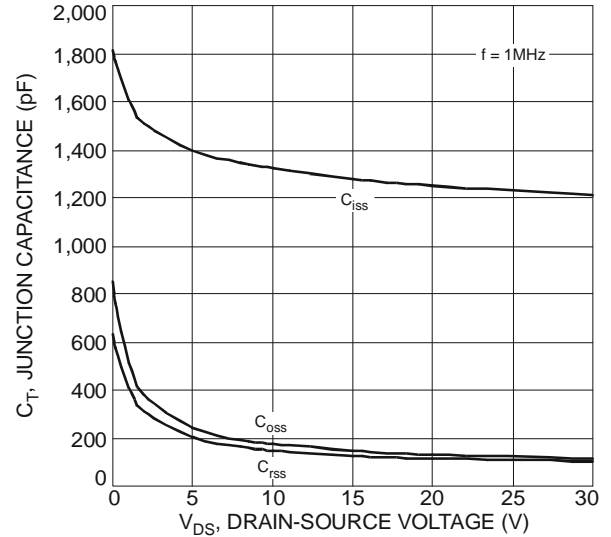

Fig. 13 Typical Junction Capacitance

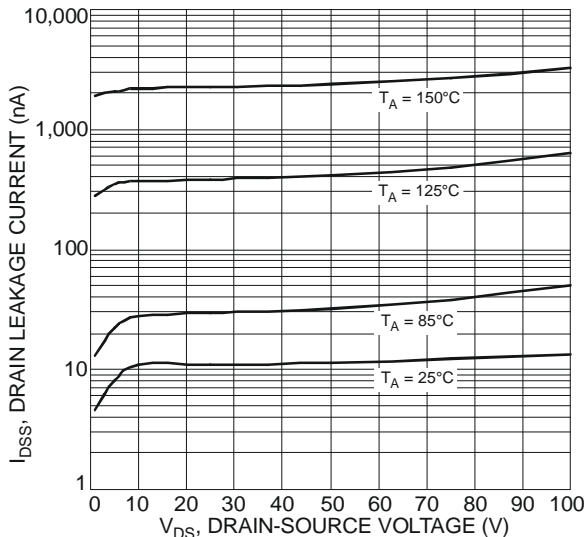

Fig. 14 Typical Drain-Source Leakage Current vs. Voltage

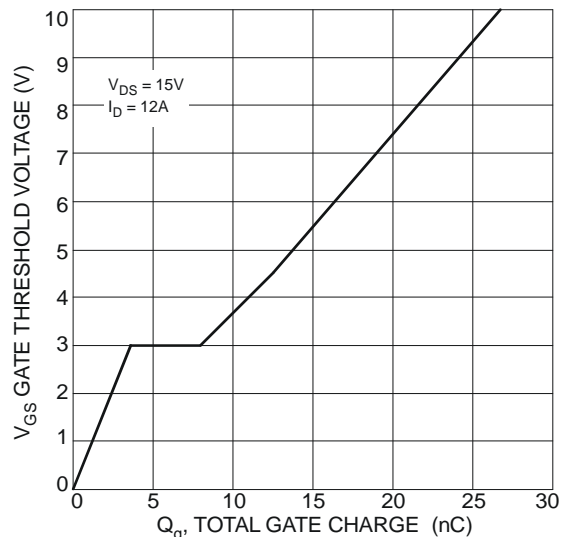
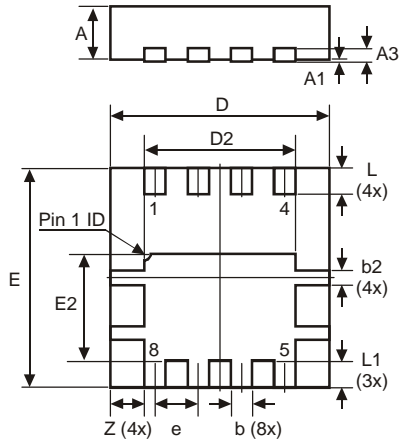

Fig. 15 Gate Charge

Package Outline Dimensions



POWERDI [®] 3333-8			
Dim	Min	Max	Typ
D	3.25	3.35	3.30
E	3.25	3.35	3.30
D2	2.22	2.32	2.27
E2	1.56	1.66	1.61
A	0.75	0.85	0.80
A1	0	0.05	0.02
A3	-	-	0.203
b	0.27	0.37	0.32
b2	-	-	0.20
L	0.35	0.45	0.40
L1	-	-	0.39
e	-	-	0.65
Z	-	-	0.515
All Dimensions in mm			

Suggested Pad Layout

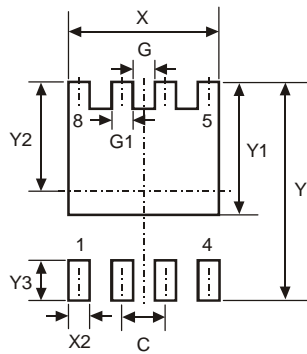

Dimensions	Value (in mm)
C	0.650
G	0.230
G1	0.420
Y	3.700
Y1	2.250
Y2	1.850
Y3	0.700
X	2.370
X2	0.420

IMPORTANT NOTICE

DIODES INCORPORATED MAKES NO WARRANTY OF ANY KIND, EXPRESS OR IMPLIED, WITH REGARDS TO THIS DOCUMENT, INCLUDING, BUT NOT LIMITED TO, THE IMPLIED WARRANTIES OF MERCHANTABILITY AND FITNESS FOR A PARTICULAR PURPOSE (AND THEIR EQUIVALENTS UNDER THE LAWS OF ANY JURISDICTION).

Diodes Incorporated and its subsidiaries reserve the right to make modifications, enhancements, improvements, corrections or other changes without further notice to this document and any product described herein. Diodes Incorporated does not assume any liability arising out of the application or use of this document or any product described herein; neither does Diodes Incorporated convey any license under its patent or trademark rights, nor the rights of others. Any Customer or user of this document or products described herein in such applications shall assume all risks of such use and will agree to hold Diodes Incorporated and all the companies whose products are represented on Diodes Incorporated website, harmless against all damages.

Diodes Incorporated does not warrant or accept any liability whatsoever in respect of any products purchased through unauthorized sales channel. Should Customers purchase or use Diodes Incorporated products for any unintended or unauthorized application, Customers shall indemnify and hold Diodes Incorporated and its representatives harmless against all claims, damages, expenses, and attorney fees arising out of, directly or indirectly, any claim of personal injury or death associated with such unintended or unauthorized application.

Products described herein may be covered by one or more United States, international or foreign patents pending. Product names and markings noted herein may also be covered by one or more United States, international or foreign trademarks.

LIFE SUPPORT

Diodes Incorporated products are specifically not authorized for use as critical components in life support devices or systems without the express written approval of the Chief Executive Officer of Diodes Incorporated. As used herein:

A. Life support devices or systems are devices or systems which:

1. are intended to implant into the body, or
2. support or sustain life and whose failure to perform when properly used in accordance with instructions for use provided in the labeling can be reasonably expected to result in significant injury to the user.

B. A critical component is any component in a life support device or system whose failure to perform can be reasonably expected to cause the failure of the life support device or to affect its safety or effectiveness.

Customers represent that they have all necessary expertise in the safety and regulatory ramifications of their life support devices or systems, and acknowledge and agree that they are solely responsible for all legal, regulatory and safety-related requirements concerning their products and any use of Diodes Incorporated products in such safety-critical, life support devices or systems, notwithstanding any devices- or systems-related information or support that may be provided by Diodes Incorporated. Further, Customers must fully indemnify Diodes Incorporated and its representatives against any damages arising out of the use of Diodes Incorporated products in such safety-critical, life support devices or systems.

Copyright © 2012, Diodes Incorporated

www.diodes.com