

●最大额定值 (Tc=25°C)

●Absolute Maximum Ratings (Tc=25°C) TO-220/220F

参数 PARAMETER	符号 SYMBOL	额定值 VALUE	单位 UNIT
漏-源电压 Drain-source Voltage	V <sub>DS</sub>	650	V
栅-源电压 gate-source Voltage	V <sub>GS</sub>	± 30	V
漏极电流 Continuous Drain Current TC=25°C	I <sub>D</sub>	4.0	A
漏极电流 Continuous Drain Current TC=100°C	I <sub>D</sub>	2.5	A
最大脉冲电流 Drain Current — Pulsed ①	I <sub>DM</sub>	16	A
耗散功率 Power Dissipation	P <sub>tot</sub>	TO-220:100	W
		TO-220F:33	
最高结温 Junction Temperature	T <sub>J</sub>	150	°C
存储温度 Storage Temperature	T <sub>STG</sub>	-55-150	°C
单脉冲雪崩能量 Single Pulse Avalanche Energy ②	E <sub>AS</sub>	128	mJ

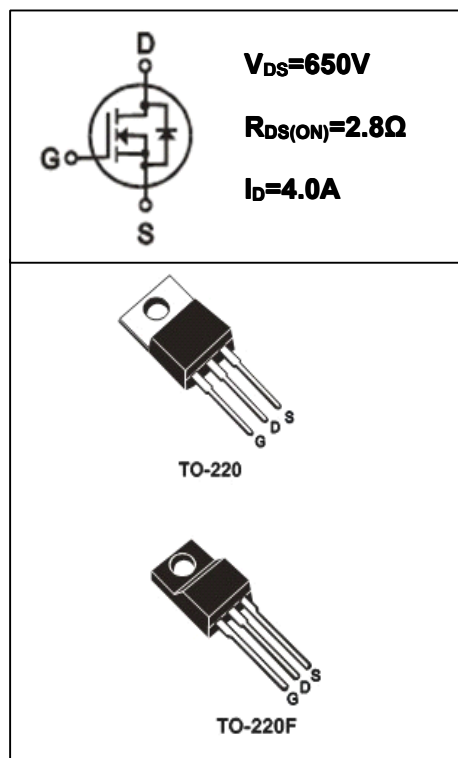

●电特性 (Tc=25°C)

●Electronic Characteristics (Tc=25°C)

参数 PARAMETER	符号 SYMBOL	测试条件 TEST CONDITION	最小值 MIN	典型值 TYP	最大值 MAX	单位 UNIT
漏-源击穿电压 Drain-source Breakdown Voltage	BV <sub>DSS</sub>	V <sub>GS</sub> =0V, I <sub>D</sub> =250μA	650			V
击穿电压温度系数 Breakdown Voltage Temperature Coefficient	ΔBV <sub>DSS</sub> / ΔT <sub>J</sub>	I <sub>D</sub> =250uA, Referenced to 25°C		0.6		V/°C
栅极开启电压 Gate Threshold Voltage	V <sub>GS(TH)</sub>	V <sub>GS</sub> =V <sub>DS</sub> , I <sub>D</sub> =250μA	2.0		4.0	V
漏-源漏电流 Drain-source Leakage Current	I <sub>DSS</sub>	V <sub>DS</sub> =650V, V <sub>GS</sub> =0V, T <sub>J</sub> =25°C			25	μA
		V <sub>DS</sub> =520V, V <sub>GS</sub> =0V, T <sub>J</sub> =125°C			250	μA
跨导 Forward Transconductance	g <sub>fs</sub>	V <sub>DS</sub> =40V, I <sub>D</sub> =2.0A ③		2.5		S

参数 PARAMETER	符号 SYMBOL	测试条件 TEST CONDITION	最小值 MIN	典型值 TYP	最大值 MAX	单位 UNIT
栅极漏电流 Gate-body Leakage Current ( $V_{DS} = 0$ )	$I_{GSS}$	$V_{GS} = \pm 30V$			$\pm 100$	nA
漏-源导通电阻 Static Drain-source On Resistance	$R_{DS(ON)}$	$V_{GS} = 10V, I_D = 2.0A$ ③		2.5	2.8	$\Omega$
输入电容 Input Capacitance	$C_{iss}$	$V_{GS} = 0V, V_{DS} = 25V$ $F = 1.0MHz$		500		pF
关断延迟 Turn -Off Delay Time	$T_d(off)$	$V_{DD} = 325V, I_D = 4.0A$ $R_G = 25\Omega$ ③		40		ns
栅极电荷 Total Gate Charge	$Q_g$	$I_D = 4.0A, V_{DS} = 520V$ $V_{GS} = 10V$ ③		15.8		nC
栅源电荷 Gate-to-Source Charge	$Q_{gs}$			3.5		nC
栅漏电荷 Gate-to-Drain Charge	$Q_{gd}$			6.0		nC
二极管正向电流 Continuous Diode Forward Current	$I_S$				4.0	A
二极管正向压降 Diode Forward Voltage	$V_{SD}$	$T_j = 25^\circ C, I_S = 4.0A$ $V_{GS} = 0V$ ③			1.4	V
反向恢复时间 Reverse Recovery Time	$t_{rr}$	$T_j = 25^\circ C, I_f = 4.0A$ $di/dt = 100A/\mu s$ ③		390		ns
反向恢复电荷 Reverse Recovery Charge	$Q_{rr}$			1.5		$\mu C$

### ●热特性

### ●Thermal Characteristics

参数 PARAMETER	符号 SYMBOL	最大值 MAX			单位 UNIT
		TO-220	TO-220F		
热阻结-壳 Thermal Resistance Junction-case	$R_{thJC}$	1.25	3.79		$^\circ C/W$
热阻结-环境 Thermal Resistance Junction-ambient	$R_{thJA}$	62.5	62.5		$^\circ C/W$

### 注释(Notes):

① 脉冲宽度：以最高结温为限制

Repetitive rating: Pulse width limited by maximum junction temperature

② 初始结温= $25^\circ C$ ,  $V_{DD} = 50V$ ,  $L = 25mH$ ,  $R_G = 25\Omega$ ,  $I_{AS} = 4.0A$

Starting  $T_j = 25^\circ C$ ,  $V_{DD} = 50V$ ,  $L = 25mH$ ,  $R_G = 25\Omega$ ,  $I_{AS} = 4.0A$

③ 脉冲测试：脉冲宽度 $\leq 300\mu s$ ，占空比 $\leq 2\%$

Pulse Test : Pulse width  $\leq 300\mu s$ , Duty cycle  $\leq 2\%$

● 特性曲线



图 1 输出特性曲线, Tc=25°C

Fig1 Typical Output Characteristics, Tc=25°C

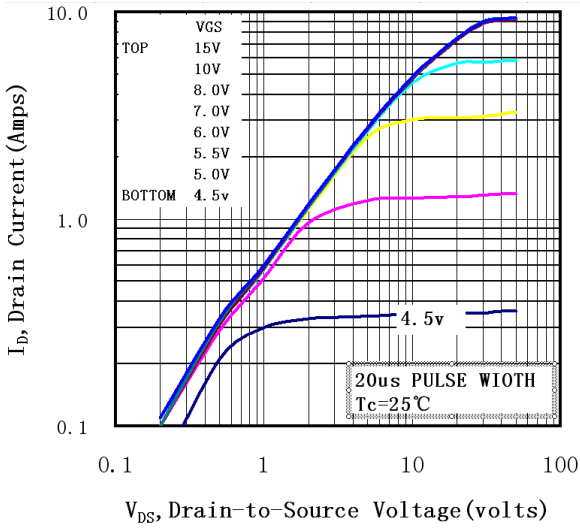

图 2 输出特性曲线, Tc=150°C

Fig2 Typical Output Characteristics, Tc=150°C

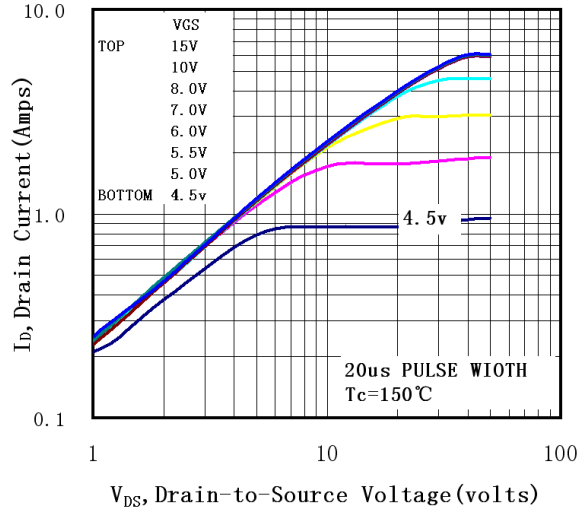

图 3 导通电阻与温度曲线

Fig3 Normalized On-Resistance Vs. Temperature

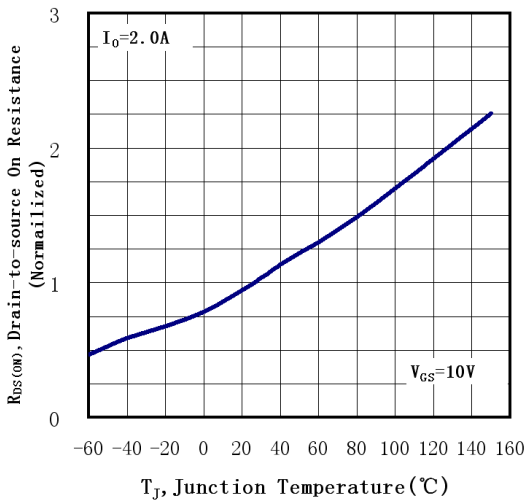

图 4 二极管正向电压曲线

Fig4 Typical Source-Drain Diode Forward Voltage

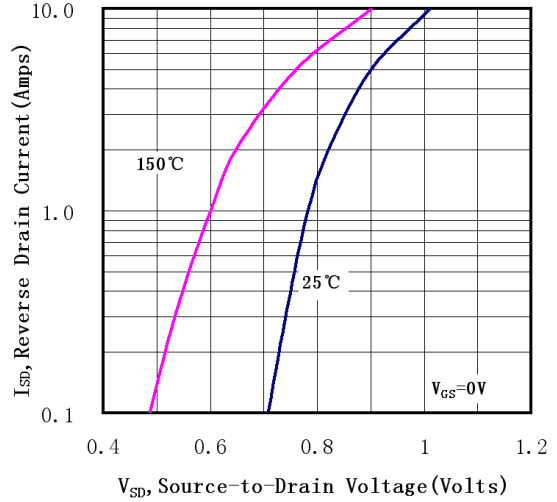

图 5 最大漏极电流与壳温曲线

Fig5 Maximum Drain Current Vs. Case Temperature

● 特性曲线

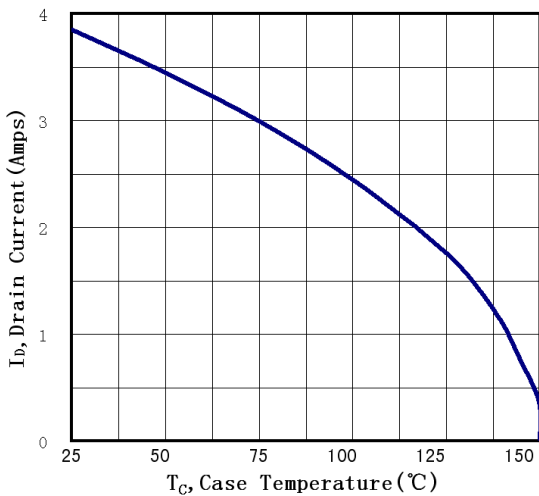
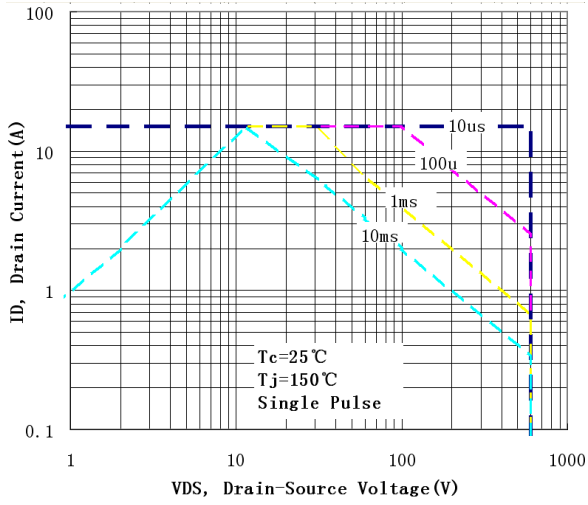

**图 6-1 4N65(TO-220)**  
最大安全工作区曲线  
Fig6-1 Maximum Safe Operating Area

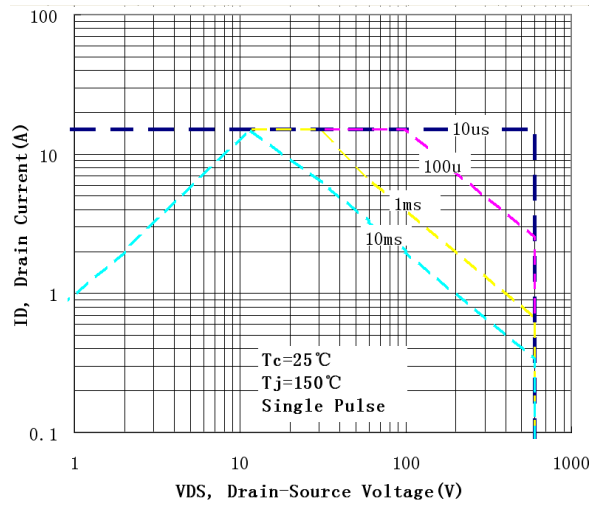

**图 6-2 4N65(TO-220F)**  
最大安全工作区曲线  
Fig6-2 Maximum Safe Operating Area

TO-220 封装

单位：毫米/UNIT: mm

符号 SYMBOL	最小值 min	典型值 nom	最大值 max	符号 SYMBOL	最小值 min	典型值 nom	最大值 max
A	4.00		4.80	E	9.90		10.70
B	1.20		1.50	e		2.54	
B1	1.00		1.40	F	1.10		1.45
b1	0.65		1.00	L	12.50		14.50
c	0.35		0.75	L1	3.00	3.50	4.00
D	15.00		16.50	Q	2.50		3.00
D1	5.90		6.90	Q1	2.00		3.00
				φP	3.60		3.90

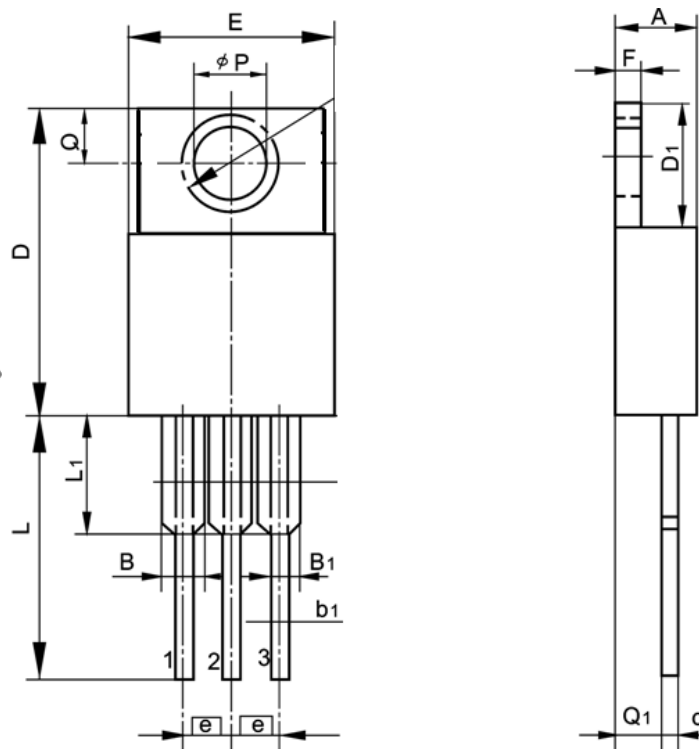

TO-220F 封装

单位:毫米/UNIT: mm

符号 SYMBOL	最小值 min	典型值 nom	最大值 max	符号 SYMBOL	最小值 min	典型值 nom	最大值 max
A	<b>4.40</b>		<b>4.95</b>	e		2.54	
A <sub>1</sub>	2.30		2.90	L	12.50		14.30
b	0.45		0.90	L <sub>1</sub>	9.10		10.05
b <sub>1</sub>	1.10		1.70	L <sub>2</sub>	15.00		16.00
c	0.35		0.90	L <sub>3</sub>	3.00		4.00
D	14.50		17.00	øp	3.00		3.50
D <sub>1</sub>	6.10		9.00	Q	2.30		2.80
E	9.60		10.30				

