

REV.	ECR/N NO./DESCRIPTION	DATE	DRAWN	CHECKED	APPROVE
9I	SN10***	04/01'11	XU	Raymond	Barney
9J	SN10***	04/01'11	XU	Raymond	Barney
9K	SN10***	05/04'11	XU	Raymond	Barney

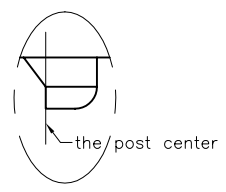

DETAIL A
SCALE 5:1

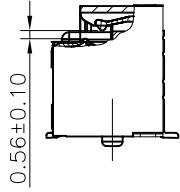
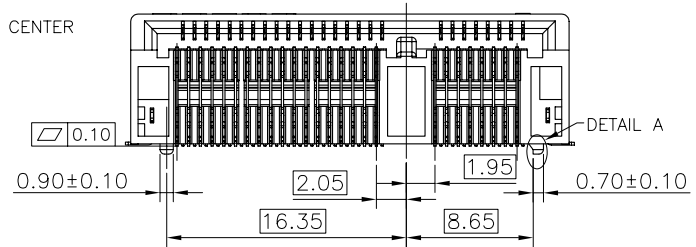
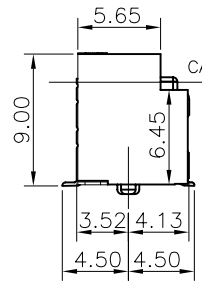
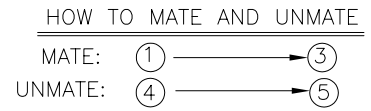
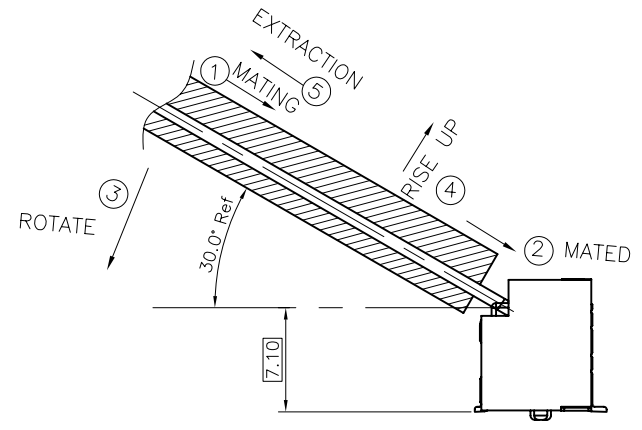
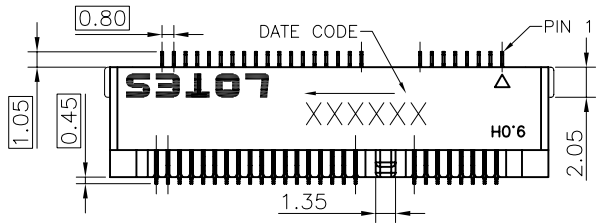
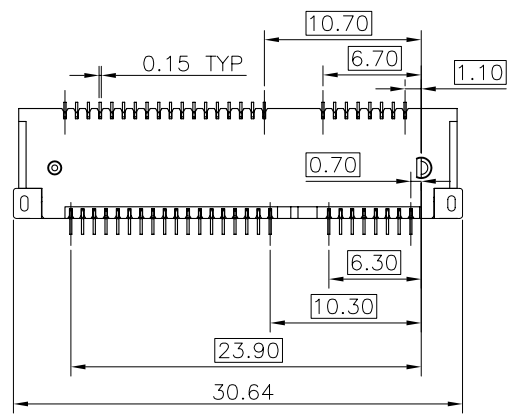

TABLE

NO.	PART NO.	DESCRIPTION
8	AAA-PCI-047-P11_A	WHITE,Au 10u",HF
7	AAA-PCI-047-P10/P10_A	BLACK,Au 10u",HF
6	AAA-PCI-047-P06	WHITE,GOLD FLASH,Au1~3u"HF
5	AAA-PCI-047-P05	BLACK,Au 30u",HF
4	AAA-PCI-047-P02	GOLD FLASH,Au1~3u"HF
3	AAA-PCI-047-K04	BLACK,Au 30u"
2	AAA-PCI-047-K01/K02	BLACK,GOLD FLASH,Au1~3u"
1	AAA-PCI-047-K01/K02	BLACK,GOLD FLASH,Au1~3u"

GENERAL TOLERANCES UNLESS SPECIFIED		PART NO.	<div style="text-align: center; font-size: 2em; font-weight: bold;"> LOTES </div>			
X.± 0.35	X.°± 3°	SEE TABLE				
.XX ± 0.25	.X° ± 2°	APPROVED BY Barney	TITLE MINI PCI EXPRESS 9.0H 0.8PITCH 52P			
.XXX ± 0.15	.XX° ± 1°	CHECKED BY Raymond	DWG NO. AP-AAA-PCI-047			
CUSTOMER DRAWING		DRAWN BY XU		SHEET 1 / 6	SCALE 2 : 1	REV 9K
SIZE A4	UNITS MM[INCH]					

NOTES:

1.MATERIAL:

CONTACT:BRASS,50u"Min.NICKEL UNDERPLATING.

GOLD PLATING ON CONTACT AREA AND ON SOLDER AREA.(DETAIL SEE TABLE)

PEG:BRASS,50u"Min.NICKEL UNDERPLATING,

MATTE-Tin 100u"Min OVER NICKEL.

HOUSING:LCP,UL-94V0

2.ROHS,HF COMPLIANT.

3.ELECTRICAL PERFORMANCE

CONTACT RESISTANCE:55mΩ MAX.PER CONTACT

INSULATION RESISTANCE:500MΩ MIN

4.MECHANICAL PERFORMANCE

DURABILITY:50 CYCLES

MATING AND UNMATING FORCE:2.3Kgf MAX

5.IR REFLOW TEMPERATURE:250°C±10°C FOR 10 SECONDS MAX.

6.PRODUCT NUMBER NOTE:AAA-PCI-***-*** *

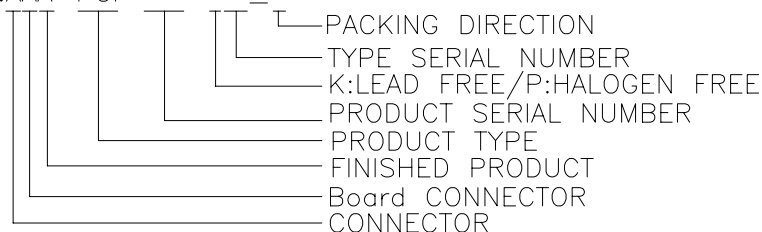

7.DATE CODE NOTE:

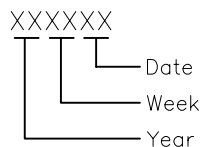

GENERAL TOLERANCES UNLESS SPECIFIED		PART NO. SEE TABLE	LOTES			
.X ± 0.35	X.° ± 3°					
.XX ± 0.25	X.° ± 2°	APPROVED BY Barney	TITLE MINI PCI EXPRESS 9.0H 0.8PITCH 52P			
.XXX ± 0.15	.XX.° ± 1°	CHECKED BY Raymond	DWG NO. AP-AAA-PCI-047			
CUSTOMER DRAWING		DRAWN BY XU		SHEET	SCALE	REV
SIZE A4	UNITS MM[INCH]			2 / 6	5 : 2	9K

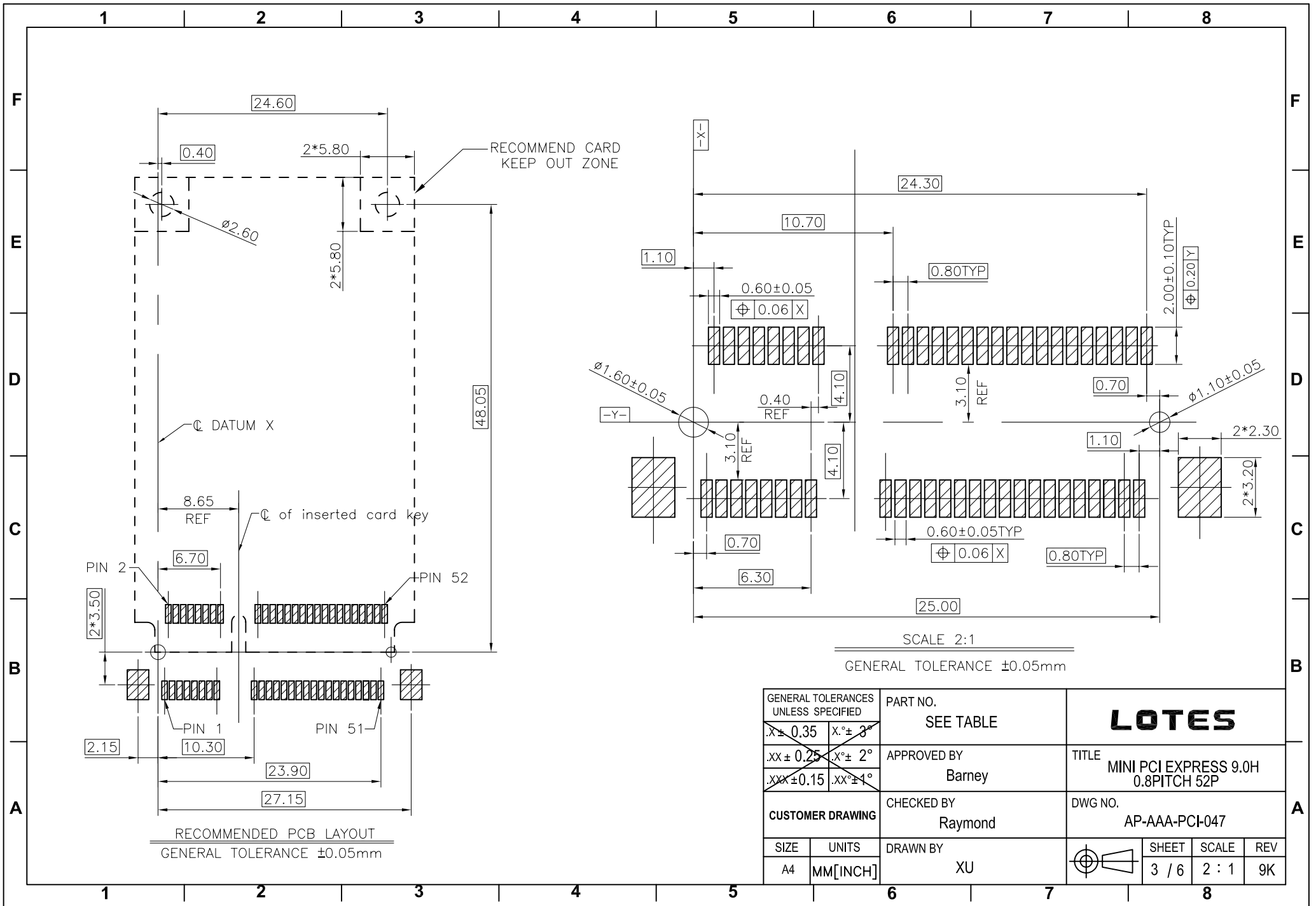

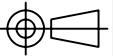
GENERAL TOLERANCES UNLESS SPECIFIED		PART NO. SEE TABLE		LOTES								
.X\pm0.35	X.$^{\circ}$$\pm3^{\circ}$	APPROVED BY Barney					TITLE MINI PCI EXPRESS 9.0H 0.8PITCH 52P					
.XX\pm0.25	X.$^{\circ}$$\pm2^{\circ}$	CHECKED BY Raymond		DWG NO. AP-AAA-PCI-047								
.XXX\pm0.15	.XX.$^{\circ}$$\pm1^{\circ}$	CUSTOMER DRAWING		DRAWN BY XU								
SIZE A4	UNITS MM[INCH]	DRAWN BY XU		 <table border="1"> <tr> <td>SHEET</td> <td>SCALE</td> <td>REV</td> </tr> <tr> <td>3 / 6</td> <td>2 : 1</td> <td>9K</td> </tr> </table>			SHEET	SCALE	REV	3 / 6	2 : 1	9K
SHEET	SCALE	REV										
3 / 6	2 : 1	9K										

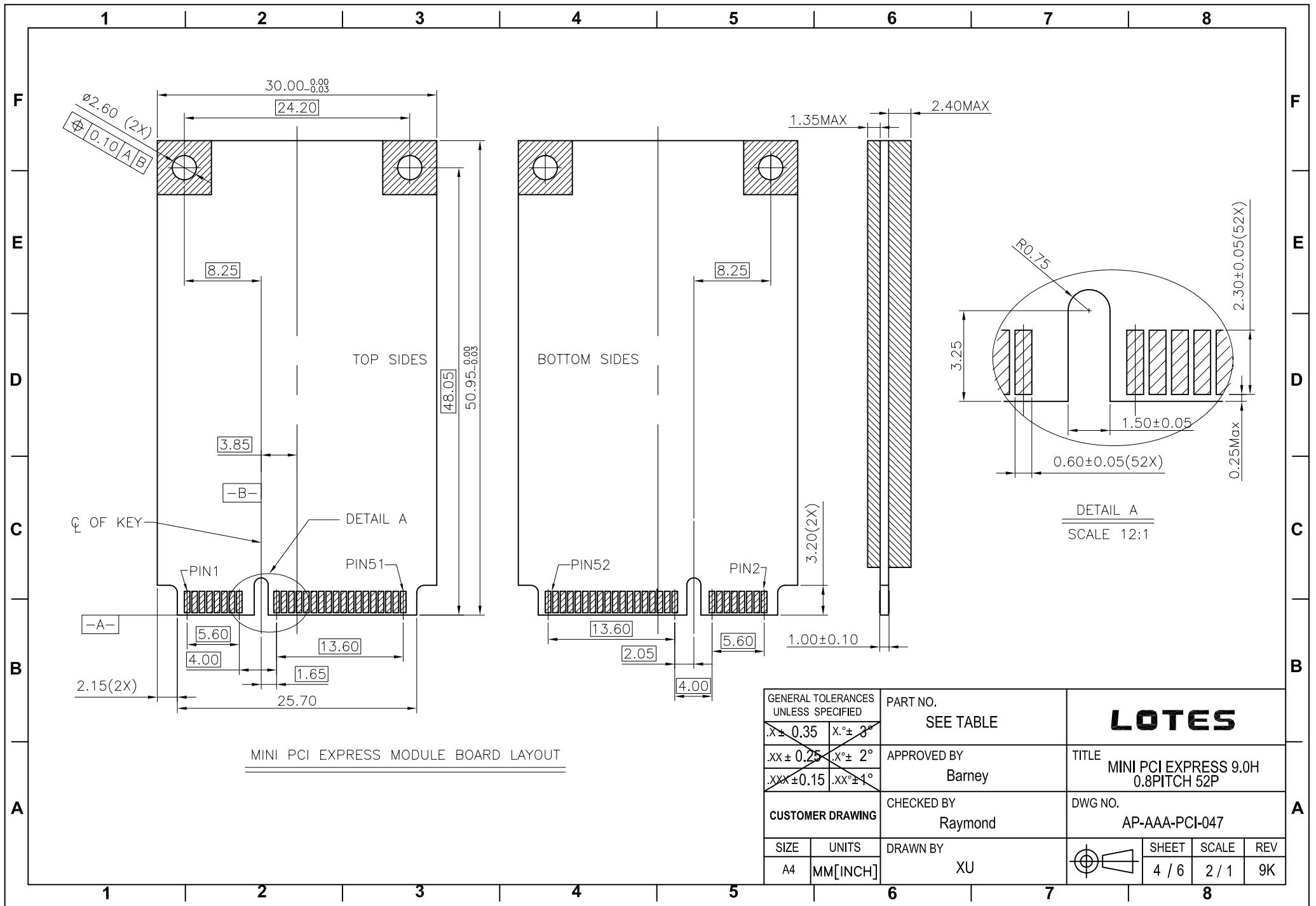

MINI PCI EXPRESS MODULE BOARD LAYOUT

GENERAL TOLERANCES UNLESS SPECIFIED		PART NO. SEE TABLE	LOTES		
.X ± 0.35	X° ± 3°				
.XX ± 0.25	X° ± 2°	APPROVED BY Barney	TITLE MINI PCI EXPRESS 9.0H 0.8PITCH 52P		
.XXX ± 0.15	.XX° ± 1°	CHECKED BY Raymond	DWG NO. AP-AAA-PCI-047		
CUSTOMER DRAWING		DRAWN BY XU	SHEET 4 / 6	SCALE 2 / 1	REV 9K
SIZE A4	UNITS MM [INCH]				

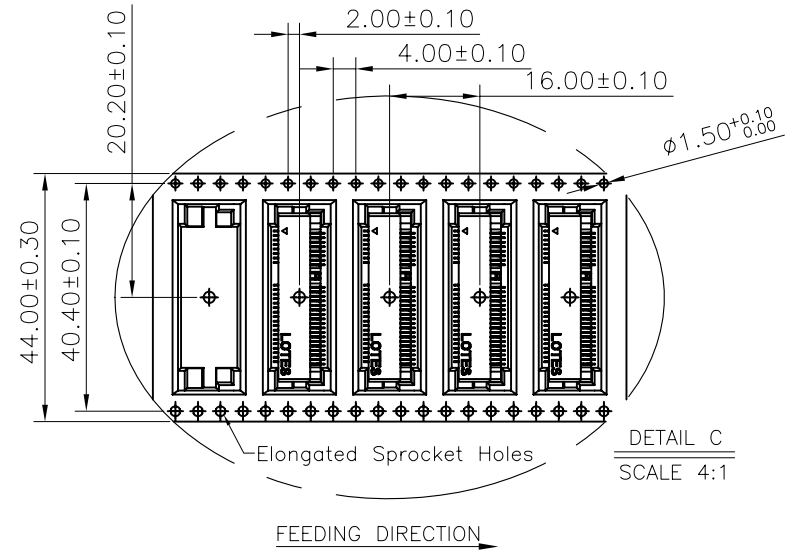
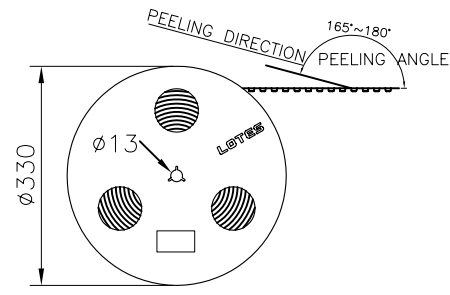
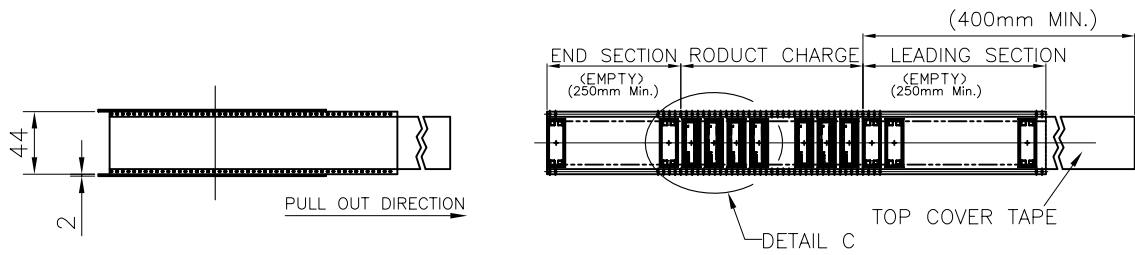

DETAIL C
SCALE 4:1

AAA-PCI-047-K01/K04//P05/P06/P10

- NOTES:
- MATERIAL :
 - CARRY TAPE: PS
 - COVER TAPE: PET
 - SHIPPING CARTON: CORRUGATED FIBER
 - DIMENSION :
 - REEL: W=44.5, $\phi A=330$
 - SHIPPING CARTON: L=335, W=335, H=300 (INNER)
 - QUANTITY :
 - PRIMARY PACKING: 350 PCS/REEL
 - SECONDARY PACKING: 6 REELS/CARTON(2100PCS)
 - PEELING RESISTANCE: 20gf~120gf.
 - PEELING SPEED: 300mm/minutes.

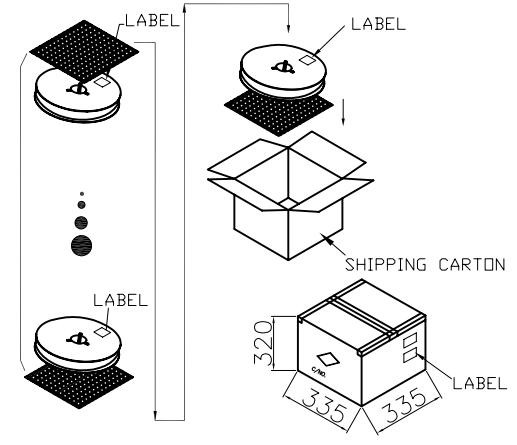

GENERAL TOLERANCES UNLESS SPECIFIED		PART NO. SEE TABLE	LOTES			
X± 0.35	X.°± 3°					
.XX ± 0.25	.X.° ± 2°	APPROVED BY Barney	TITLE MINI PCI EXPRESS 9.0H 0.8PITCH 52P			
.XXX ± 0.15	.XX.° ± 1°	CHECKED BY Raymond	DWG NO. AP-AAA-PCI-047			
CUSTOMER DRAWING		DRAWN BY XU	SHEET 5 / 6	SCALE N/A	REV 9K	
SIZE A4	UNITS MM[INCH]					

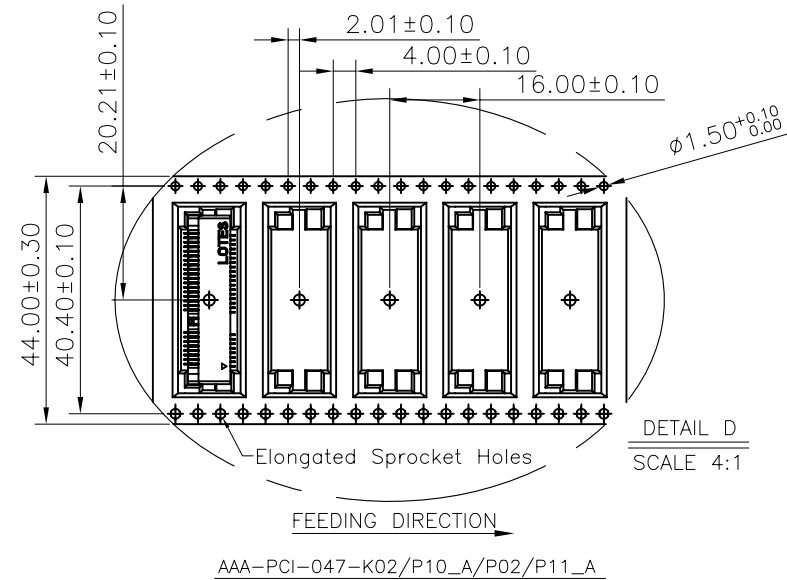
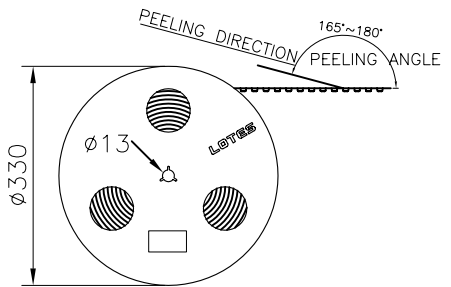
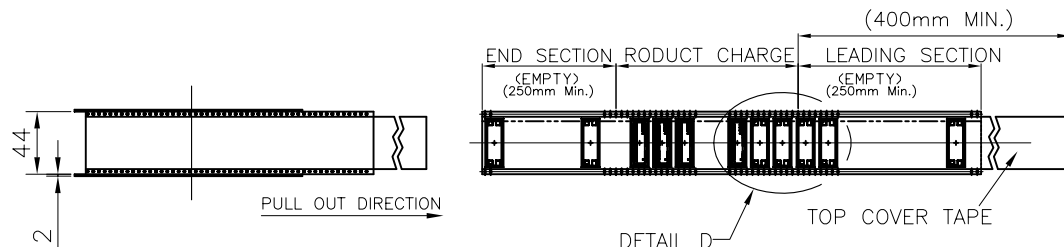

DETAIL D
SCALE 4:1

- NOTES:
- MATERIAL :
 - CARRY TAPE: PS
 - COVER TAPE: PET
 - SHIPPING CARTON: CORRUGATED FIBER
 - DIMENSION :
 - REEL: W=44.5, $\phi A=330$
 - SHIPPING CARTON: L=335, W=335, H=320 (INNER)
 - QUANTITY :
 - PRIMARY PACKING: 350 PCS/REEL
 - SECONDARY PACKING: 6 REELS/CARTON(2100PCS)
 - PEELING RESISTANCE: 20gf~120gf.
 - PEELING SPEED: 300mm/minutes.

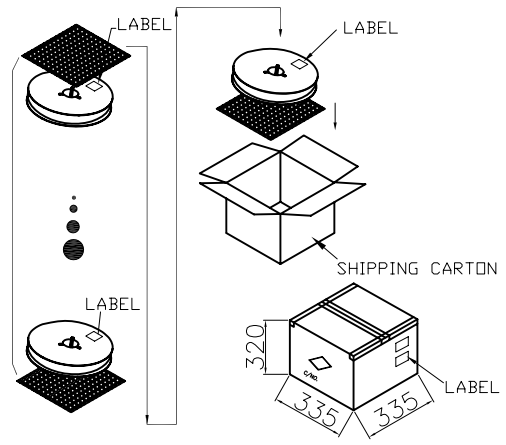

GENERAL TOLERANCES UNLESS SPECIFIED		PART NO. SEE TABLE	LOTES			
.X \pm 0.35	X. $^{\circ}$ \pm 3 $^{\circ}$					
.XX \pm 0.25	.X. $^{\circ}$ \pm 2 $^{\circ}$	APPROVED BY Barney	TITLE MINI PCI EXPRESS 9.0H 0.8PITCH 52P			
.XXX \pm 0.15	.XX. $^{\circ}$ \pm 1 $^{\circ}$	CHECKED BY Raymond	DWG NO. AP-AAA-PCI-047			
SIZE	UNITS	DRAWN BY		SHEET	SCALE	REV
A4	MM[INCH]	XU		6 / 6	N/A	9K