

Inductors for power circuits

Wound ferrite

CLF-NI-D series (for automotive)



AEC-Q200

CLF7045NI-D type



FEATURES

- Magnetic shield type wound inductor for power circuits.
- It can be used at a wide temperature range. -55 to +150°C (including self-temperature rise)
- 1 to 470μH, wide E-6 series lineup allows for various usages.
- Operating temperature range: -55 to +150°C (including self-temperature rise)
- Compliant with AEC-Q200

APPLICATION

- Automotive-related equipment (ECM, airbags, headlights, electronic power steering, meters, ABS, other)
- Application guides: [Automotive \(xEV\)](#)

PART NUMBER CONSTRUCTION

CLF7045NI	T	-	1R0	N	-	D
Series name	Packaging style		Inductance (μH)	Inductance tolerance		Internal code

CHARACTERISTICS SPECIFICATION TABLE

L (μH)	Measuring frequency (kHz)	DC resistance (Ω)	Rated current*		Itemp (A)typ.	Part No.	
			Isat (A)max.	(A)typ.			
1.0	±30%	100	0.009±30%	8.50	11.0	6.50	CLF7045NIT-1R0N-D
1.5	±30%	100	0.010±30%	6.30	8.60	5.40	CLF7045NIT-1R5N-D
2.2	±30%	100	0.013±30%	6.20	6.30	5.10	CLF7045NIT-2R2N-D
3.3	±30%	100	0.016±30%	4.70	6.00	4.80	CLF7045NIT-3R3N-D
4.7	±30%	100	0.018±30%	4.10	4.80	4.10	CLF7045NIT-4R7N-D
6.8	±30%	100	0.022±30%	3.10	4.10	3.90	CLF7045NIT-6R8N-D
10	±20%	100	0.033±20%	3.00	3.40	3.10	CLF7045NIT-100M-D
15	±20%	100	0.055±20%	2.30	2.80	2.60	CLF7045NIT-150M-D
22	±20%	100	0.069±20%	1.70	2.40	2.20	CLF7045NIT-220M-D
33	±20%	100	0.097±20%	1.60	1.90	1.80	CLF7045NIT-330M-D
47	±20%	100	0.130±20%	1.26	1.60	1.70	CLF7045NIT-470M-D
68	±20%	100	0.170±20%	1.08	1.30	1.50	CLF7045NIT-680M-D
100	±20%	100	0.260±20%	0.81	1.10	1.05	CLF7045NIT-101M-D
150	±20%	100	0.430±20%	0.69	0.89	0.95	CLF7045NIT-151M-D
220	±20%	100	0.550±20%	0.56	0.71	0.75	CLF7045NIT-221M-D
330	±20%	100	0.800±20%	0.50	0.60	0.58	CLF7045NIT-331M-D
470	±20%	100	1.200±20%	0.41	0.50	0.46	CLF7045NIT-471M-D

* Rated current: smaller value of either Isat or Itemp.

Isat: When based on the inductance change rate (30% below the nominal value)

Itemp: When based on the temperature increase (temperature increase of 40°C by self heating)

Measurement equipment

Measurement item	Product No.	Manufacturer
L	4285A	Keysight Technologies
DC resistance	AN-114N	ADEX
Rated current Isat	4285A+42841A+42842C	Keysight Technologies

* Equivalent measurement equipment may be used.



CLF7045NI-D type

L FREQUENCY CHARACTERISTICS

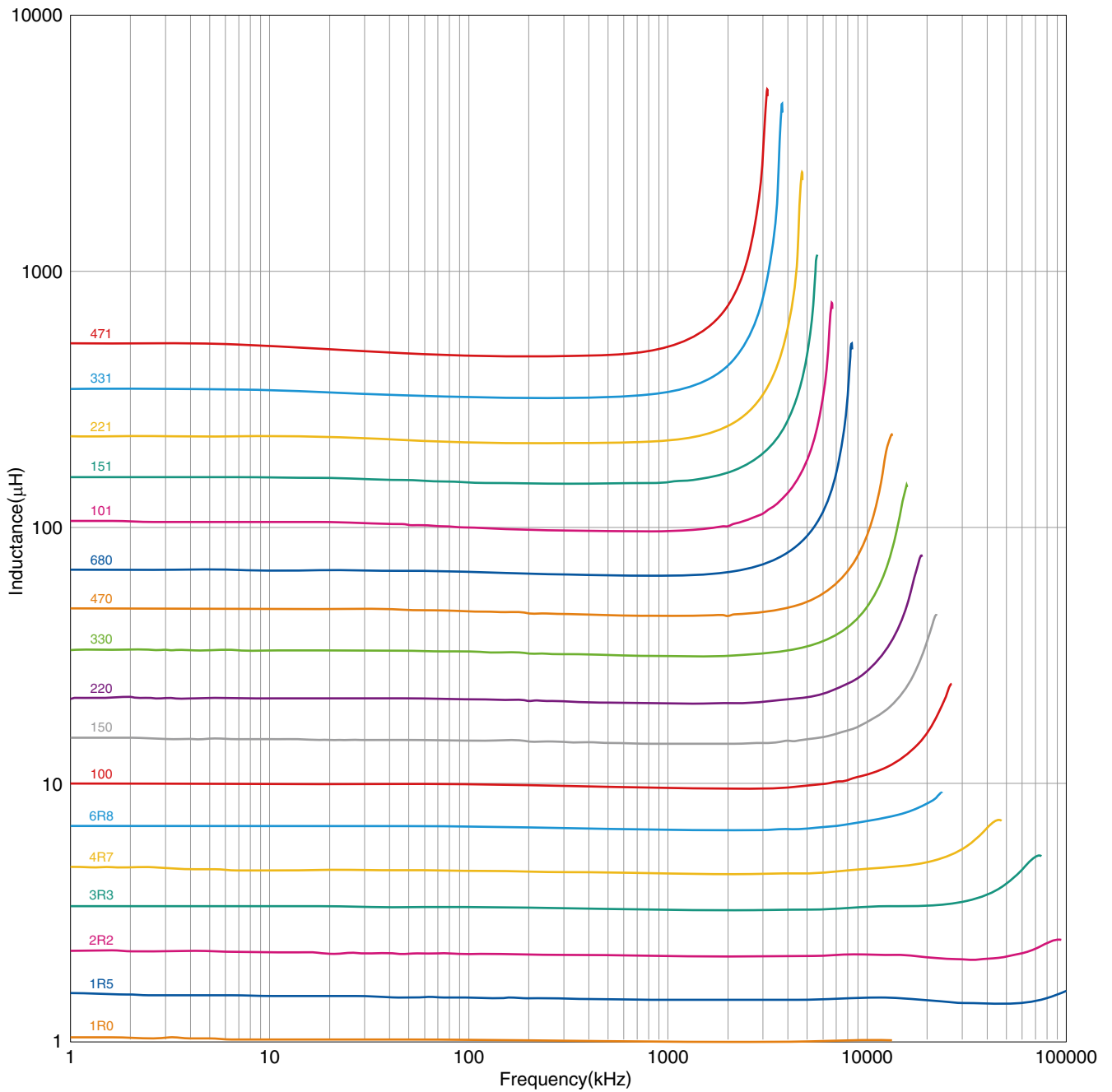

Measurement equipment

Product No.	Manufacturer
4294A	Keysight Technologies

* Equivalent measurement equipment may be used.

CLF7045NI-D type

INDUCTANCE VS. DC BIAS CHARACTERISTICS

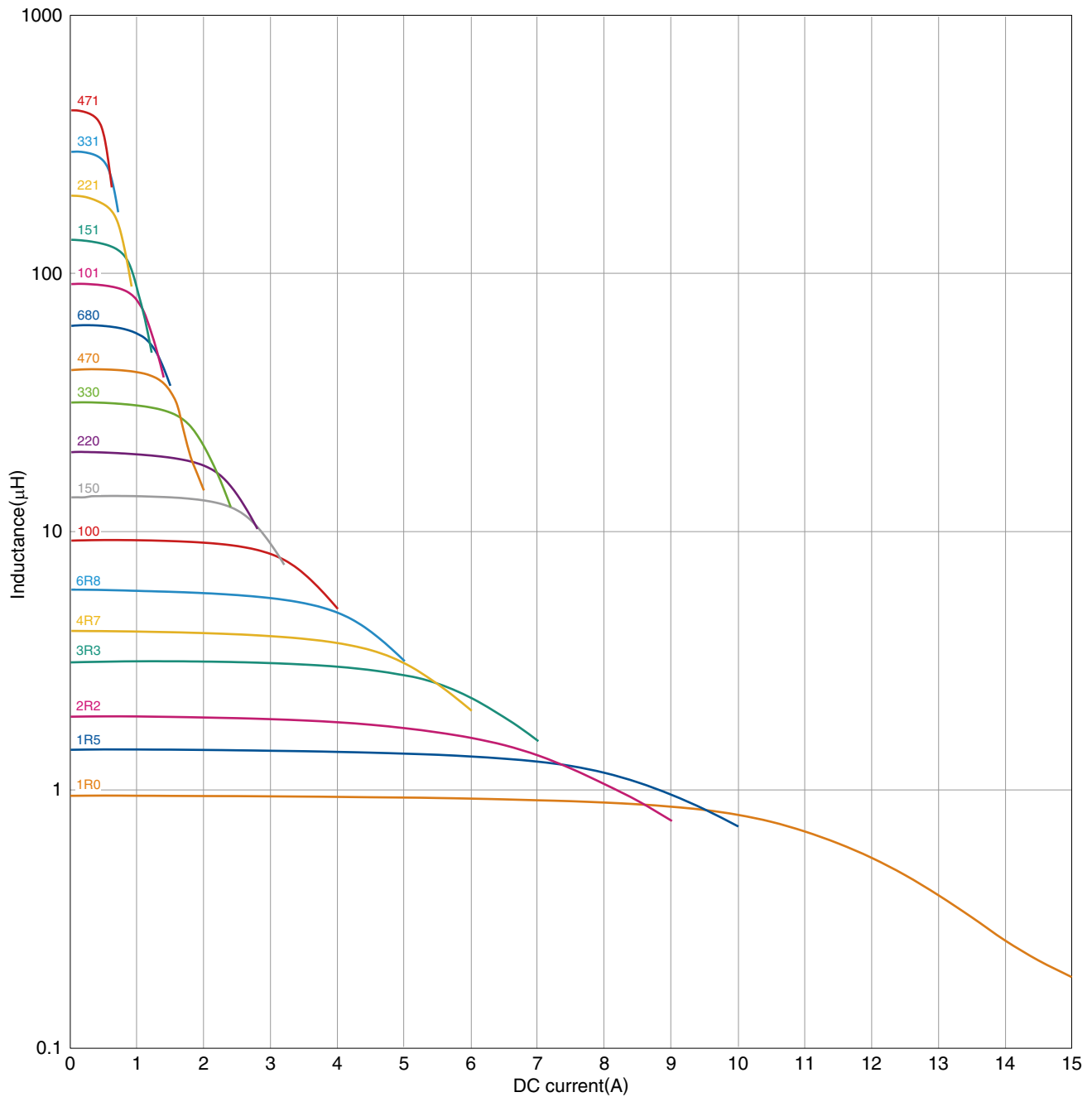

Measurement equipment

Product No.	Manufacturer
4285A+42841A+42842C	Keysight Technologies

* Equivalent measurement equipment may be used.

CLF7045NI-D type

SHAPE & DIMENSIONS

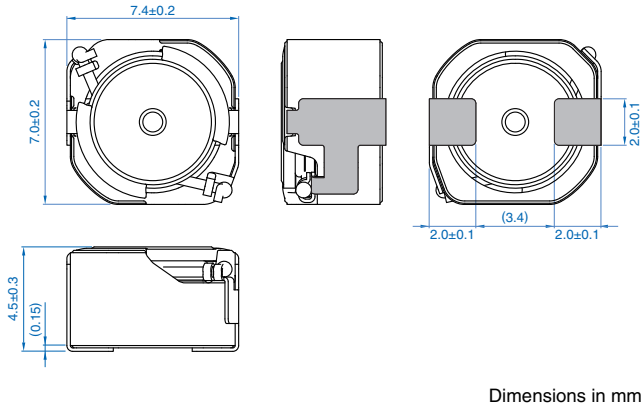

Dimensions in mm

PACKAGING STYLE

REEL DIMENSIONS

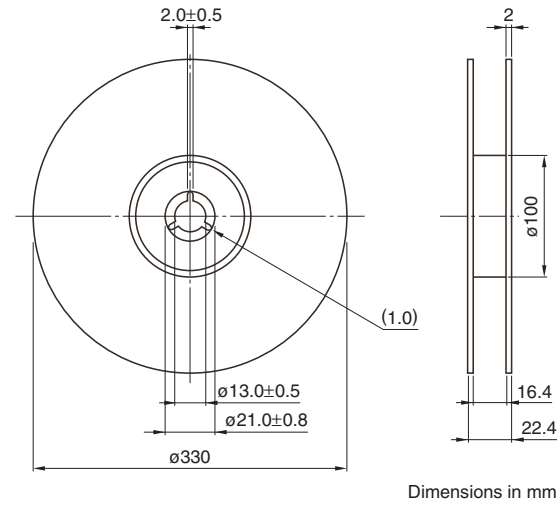

Dimensions in mm

RECOMMENDED LAND PATTERN

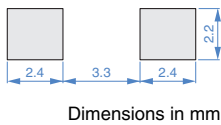

Dimensions in mm

TAPE DIMENSIONS

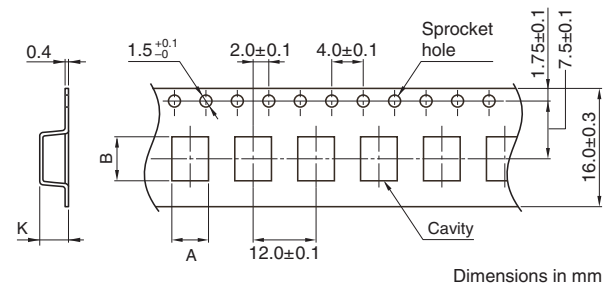

Dimensions in mm

RECOMMENDED REFLOW PROFILE

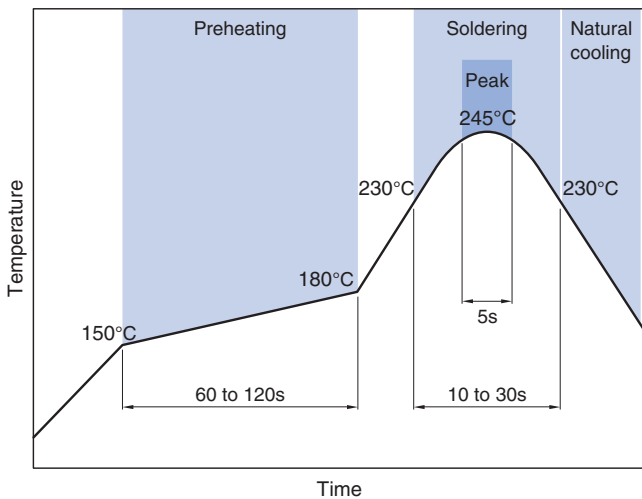

Type	A	B	K
CLF7045NI-D	7.8	7.4	5.4

PACKAGE QUANTITY

Package quantity	1000 pcs/reel
------------------	---------------

TEMPERATURE RANGE, INDIVIDUAL WEIGHT

Operating temperature range*	Storage temperature range**	Individual weight
-55 to +150 °C	-55 to +150 °C	0.8 g

* Operating temperature range includes self-temperature rise.

** The storage temperature range is for after the assembly.

REMINDERS FOR USING THESE PRODUCTS

Before using these products, be sure to request the delivery specifications.

SAFETY REMINDERS

Please pay sufficient attention to the warnings for safe designing when using this products.

REMINDERS

- The storage period is less than 12 months. Be sure to follow the storage conditions (temperature: 5 to 40°C, humidity: 10 to 75% RH or less).
If the storage period elapses, the soldering of the terminal electrodes may deteriorate.
- Soldering corrections after mounting should be within the range of the conditions determined in the specifications.
If overheated, a short circuit, performance deterioration, or lifespan shortening may occur.
- Do not use products that have received any excessive mechanical shock such as by being dropped.
- When embedding a printed circuit board where a chip is mounted to a set, be sure that residual stress is not given to the chip due to the overall distortion of the printed circuit board and partial distortion such as at screw tightening portions.
- Self heating (temperature increase) occurs when the power is turned ON, so the tolerance should be sufficient for the set thermal design.
- Do not expose the products to magnets or magnetic fields.
- The performance of the product may deteriorate if coating materials are used, thus please assess the situation beforehand by taking this factor into consideration.
- Do not use for a purpose outside of the contents regulated in the delivery specifications.
- The products listed on this catalog are intended for use in general electronic equipment (AV equipment, telecommunications equipment, home appliances, amusement equipment, computer equipment, personal equipment, office equipment, measurement equipment, industrial robots) under a normal operation and use condition.
The products are not designed or warranted to meet the requirements of the applications listed below, whose performance and/or quality require a more stringent level of safety or reliability, or whose failure, malfunction or trouble could cause serious damage to society, person or property.
If you intend to use the products in the applications listed below or if you have special requirements exceeding the range or conditions set forth in the each catalog, please contact us.

- (1) Aerospace/aviation equipment
- (2) Transportation equipment (electric trains, ships, etc.)
- (3) Medical equipment
- (4) Power-generation control equipment
- (5) Atomic energy-related equipment
- (6) Seabed equipment
- (7) Transportation control equipment

- (8) Public information-processing equipment
- (9) Military equipment
- (10) Electric heating apparatus, burning equipment
- (11) Disaster prevention/crime prevention equipment
- (12) Safety equipment
- (13) Other applications that are not considered general-purpose applications

When designing your equipment even for general-purpose applications, you are kindly requested to take into consideration securing protection circuit/device or providing backup circuits in your equipment.